

**2 YEARS Warranty**  
(Power Source)

**UNI-MIG**  
**WELDING** 



# OPERATING MANUAL

## KMM180



Please read and understand this instruction manual carefully before the installation and operation of this equipment.

## WARRANTY

---

- 2 Years from date of purchase.
- Welding Guns Of Australia PTY LTD Ltd warranties all goods as specified by the manufacturer of those goods.
- This Warranty does not cover freight or goods that have been interfered with.
- All goods in question must be repaired by an authorised repair agent as appointed by this company.
- Warranty does not cover abuse, mis-use, accident, theft, general wear and tear.
- New product will not be supplied unless Welding Guns Of Australia PTY LTD has inspected product returned for warranty and agree's to replace product.
- Product will only be replaced if repair is not possible
- Please view full Warranty term and conditions supplied with machine or at [www.unimig.com.au/warranty.asp](http://www.unimig.com.au/warranty.asp) or at the back of this manual.

## **Thank you for your purchase of your UNI-MIG welding machine.**

---



We are proud of our range of welding equipment that has a proven track record of innovation, performance and reliability.

Our product range represents the latest developments in Mig machine design put together by our professional team of highly skilled engineers. The expertise gained from our long involvement with welding machine design has proven to be invaluable towards the evolution and future development of our equipment range. This experience gives us the inside knowledge on what the arc characteristics, performance and interface between man and machine should be.

Within our team are specialist welders that have a proven history of welding knowledge and expertise, giving vital input towards ensuring that our machines deliver control and performance to the utmost professional level.

We employ an expert team of professional sales, marketing and technical personnel that provide us with market trends, market feedback and customer comments and requirements. Secondly they provide a customer support service that is second to none, thus ensuring our customers have confidence that they will be well satisfied both now and in the future.

UNI-MIG welders are manufactured and compliant with - AS/NZ60974.1 2006 - guaranteeing you electrical safety and performance. The Mini-Mig 180 has been issued electrical approval number ESV110294.

# **CONTENTS**

# **PAGE**

Warranty	2
Technical Data, Product Information	5
Safety - Cautions	7-8
Machine Layout Pictogram	9
Installation Operation Cautions	10
Installation & Operation for MIG Welding with Gas	11-12
Wire Feed Drive Roller Selection	13
Wire Installation Set up Guide	14
Installation & Operation for MIG Welding with No Gas	15-16
Installation Guide for Mig Torch Liner Installation	17
Mig Torch and Wire Feeder Set Up Guide for Aluminium Mig Wire	18-19
Installation & Operation for MIG Welding with Spool Gun	20-21
MIG (Metal Inert Gas) Welding	22-23
Basic MIG Welding Guide	24-27
SB15 MIG Torch Parts Breakdown	28-29
SP135 Spool Gun Torch Parts Breakdown	30-31
Mig Welding Trouble Shooting Guide	32-33
Attention Gas Leaks	34
Machine Spare Parts Breakdown	35
Warranty Period / Returns / Exchanges / Exclusions	36-38



### MIG - 180 Amp DC Welding Machine Light weight & Portable

#### Features

- Thermal Overload Protection
- Fan Cooled
- Single Phase 240Volt
- 35-180AMP
- 1-5 Kg Spool Capacity
- Fully Compliant to AS 60974.1
- Gas / Gasless
- Euro Connect Torch
- Spool Gun Ready



#### Technical Data

PRIMARY INPUT VOLTAGE	240V 1 Phase
WELDING CURRENT	35 - 180 Amps
VOLTAGE STEPS	6
DUTY CYCLE 40°C	10% — 180 Amps 60% — 74 Amps 100% — 60 Amps
WELDING VOLTAGE RANGE DC	14.5V – 23V
OVERLOAD PROTECTION	Standard
REVERSE POLARITY	Standard
WIRE SPOOL SIZE	1 & 5 Kgs
WEIGHT (Kgs)	30 Kgs
Warranty	2 years on machine only

#### MINI MIG OPTIONS



**SPOOL GUN**  
Part No: SPG135



**MACHINE TROLLEY**  
Part No: UMJRTROLLEY2

#### MACHINE PACKAGE: KMM180

SB15 3M Euro Connect Torch, 3M EARTH Direct Connect Lead, UNI-FLAME Twin Gauge Argon Regulator, 2M Gas Hose Complete with fittings, 1 x 0.5Kg Spool Solid Wire plus drive roller, 1 x 0.45Kg Spool Gasless Wire plus drive

# SAFETY

Welding and cutting equipment can be dangerous to both the operator and people in or near the surrounding working area, if the equipment is not correctly operated. Equipment must only be used under the strict and comprehensive observance of all relevant safety regulations. Read and understand this instruction manual carefully before the installation and operation of this equipment.

## Machine Operating Safety

- Do not switch the voltage switch while the machine is welding. Switching of the voltage switch during welding can damage the machine. Damage caused in this manner will not be covered under warranty.
- Operators should be trained and or qualified.

**Electric shock: It can kill.** Touching live electrical parts can cause fatal shocks or severe burns. The electrode and work circuit is electrically live whenever the output is on. The input power circuit and internal machine circuits are also live when power is on. In Mig/Mag welding, the wire, drive rollers, wire feed housing, and all metal parts touching the welding wire are electrically live. Incorrectly installed or improperly grounded equipment is dangerous.



- Connect the primary input cable according to Australian and New Zealand standards and regulations.
- Avoid all contact with live electrical parts of the welding circuit, electrodes and wires with bare hands. The operator must wear dry welding gloves while he/she performs the welding task.
- The operator should keep the work piece insulated from himself/herself.
- Keep cords dry, free of oil and grease, and protected from hot metal and sparks.
- Frequently inspect input power cable for wear and tear, replace the cable immediately if damaged, bare wiring is dangerous and can kill.
- Do not use damaged, under sized, or badly joined cables.
- Do not drape cables over your body.

**Fumes and gases are dangerous.** Smoke and gas generated whilst welding or cutting can be harmful to people's health. Welding produces fumes and gases. Breathing these fumes and gases can be hazardous to your health.



- Do not breathe the smoke and gas generated whilst welding or cutting, keep your head out of the fumes
- Keep the working area well ventilated, use fume extraction or ventilation to remove welding fumes and gases.
- In confined or heavy fume environments always wear an approved air-supplied respirator. Welding fumes and gases can displace air and lower the oxygen level causing injury or death. Be sure the breathing air is safe.
- Do not weld in locations near de-greasing, cleaning, or spraying operations. The heat and rays of the arc can react with vapours to form highly toxic and irritating gases.
- Materials such as galvanized, lead, or cadmium plated steel, containing elements that can give off toxic fumes when welded. Do not weld these materials unless the area is very well ventilated, and or wearing an air supplied respirator.



**Arc rays: harmful to people's eyes and skin.** Arc rays from the welding process produce intense visible and invisible ultraviolet and infrared rays that can burn eyes and skin.

- Always wear a welding helmet with correct shade of filter lens and suitable protective clothing including welding gloves whilst the welding operation is performed.
- Measures should be taken to protect people in or near the surrounding working area. Use protective screens or barriers to protect others from flash, glare and sparks; warn others not to watch the arc.



**Fire hazard.** Welding on closed containers, such as tanks, drums, or pipes, can cause them to explode. Flying sparks from the welding arc, hot work piece, and hot equipment can cause fires and burns. Accidental contact of electrode to metal objects can cause sparks, explosion, overheating, or fire. Check and be sure the area is safe before doing any welding.

- The welding sparks may cause fire, therefore remove any flammable materials away from the working area, at least 12m from the welding arc. Cover flammable materials and containers with approved covers if unable to be moved from the welding area.
- Do not weld on closed containers such as tanks, drums, or pipes, unless they are properly prepared according to the required Safety Standards to insure that flammable or toxic vapors and substances are totally removed, these can cause an explosion even though the vessel has been “cleaned”. Vent hollow castings or containers before heating, cutting or welding. They may explode.
- Do not weld where the atmosphere may contain flammable dust, gas, or liquid vapours (such as petrol)
- Have a fire extinguisher nearby and know how to use it. Be alert that welding sparks and hot materials from welding can easily go through small cracks and openings to adjacent areas. Be aware that welding on a ceiling, floor, bulkhead, or partition can cause fire on the hidden side.

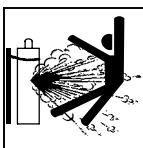

**Gas Cylinders.** Shielding gas cylinders contain gas under high pressure. If damaged, a cylinder can explode. Because gas cylinders are normally part of the welding process, be sure to treat them carefully. **CYLINDERS** can explode if damaged.

- Protect gas cylinders from excessive heat, mechanical shocks, physical damage, slag, open flames, sparks, and arcs.
- Ensure cylinders are held secure and upright to prevent tipping or falling over.
- Never allow the welding electrode or earth clamp to touch the gas cylinder, do not drape welding cables over the cylinder.
- Never weld on a pressurised gas cylinder, it will explode and kill you.
- Open the cylinder valve slowly and turn your face away from the cylinder outlet valve and gas regulator.



**Gas build up.** The build up of gas can causes a toxic environment, deplete the oxygen content in the air resulting in death or injury. Many gases use in welding are invisible and odourless.

- Shut off shielding gas supply when not in use.
- Always ventilate confined spaces or use approved air-supplied respirator.

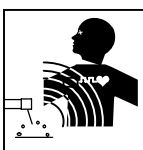

**Electronic magnetic fields.** **MAGNETIC FIELDS** can affect Implanted Medical Devices.

- Wearers of Pacemakers and other Implanted Medical Devices should keep away.
- Implanted Medical Device wearers should consult their doctor and the device manufacturer before going near any electric welding, cutting or heating operation.

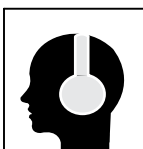

**Noise can damage hearing.** Noise from some processes or equipment can damage hearing. Wear approved ear protection if noise level is high.



**Hot parts.** Items being welded generate and hold high heat and can cause severe burns. Do not touch hot parts with bare hands. Allow a cooling period before working on the welding gun. Use insulated welding gloves and clothing to handle hot parts and prevent burns.

## CAUTION



### 1. Working Environment.

- 1.1 The environment in which this welding equipment is installed must be free of grinding dust, corrosive chemicals, flammable gas or materials etc, and at no more than maximum of 80% humidity.
- 1.2 When using the machine outdoors protect the machine from direct sun light, rain water and snow etc; the temperature of working environment should be maintained within -10°C to +40°C.
- 1.3 Keep this equipment 30cm distant from the wall.
- 1.4 Ensure the working environment is well ventilated.

### 2. Safety Tips.

#### 2.1 Ventilation

This equipment is small-sized, compact in structure, and of excellent performance in amperage output. The fan is used to dissipate heat generated by this equipment during the welding operation.

**Important:** Maintain good ventilation of the louvers of this equipment. The minimum distance between this equipment and any other objects in or near the working area should be 30 cm. Good ventilation is of critical importance for the normal performance and service life of this equipment.

#### 2.2 Thermal Overload protection.

Should the machine be used to an excessive level, or in high temperature environment, poorly ventilated area or if the fan malfunctions the Thermal Overload Switch will be activated and the machine will cease to operate. Under this circumstance, leave the machine switched on to keep the built-in fan working to bring down the temperature inside the equipment. The machine will be ready for use again when the internal temperature reaches safe level.

#### 2.3 Over-Voltage Supply

Regarding the power supply voltage range of the machine, please refer to “Main parameter” table. In case that the voltage of input power supply amperage exceeds the stipulated value, it is possible to cause damage to the components of this equipment. Please ensure your primary power supply is correct.

- 2.4 Do not come into contact with the output terminals while the machine is in operation. An electric shock may possibly occur.

## MAINTENANCE

Exposure to extremely dusty, damp, or corrosive air is damaging to the welding machine. In order to prevent any possible failure or fault of this welding equipment, clean the dust at regular intervals with clean and dry compressed air of required pressure.

**Please note that:** lack of maintenance can result in the cancellation of the guarantee; the guarantee of this welding equipment will be void if the machine has been modified. Any attempt to take apart the machine or open the factory-made sealing of the machine without the consent of an authorized representative of the manufacturer.

## TROUBLE SHOOTING

Caution: Only qualified technicians are authorized to undertake the repair of this welding equipment. For your safety and to avoid Electrical Shock, please observe all safety notes and precautions detailed in this manual.

### Note:

Minimum Motor Generator Power Suggested:- 7KVA for MIG180



## FRONT PANEL LAYOUT

1. ON/OFF Power Switch
2. Wire Speed Adjustment Knob
3. Thermal Overload Light
4. Voltage Selection Knob
5. SpoolGun Power Supply Connection
6. Earth Lead
7. Primary Power Supply Connection
8. Standard Mig/Spool Gun Selector Switch
9. Euro Mig Torch Connector (MIG/MAG)



## BACK PANEL LAYOUT

10. Gas Inlet
11. Fan
12. Data Plate



## INTERNAL PANEL LAYOUT

13. DC Positive output terminal
14. DC Negative output terminal
15. Wire feeder mechanism
16. Spool holder assembly

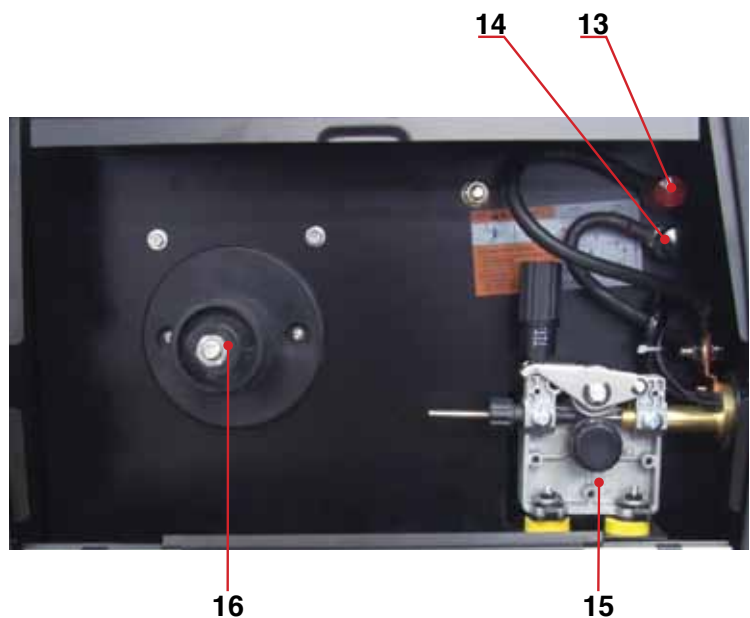

## INSTALLATION & OPERATION

---



**Please install the machine strictly according to the following steps.  
The protection class of this machine is IP21S, so avoid using it in rain.**

### **Connection of Input Cables**

Primary input cable is supplied with this welding equipment. Connect the primary input cable with power supply of required input voltage. Refer to data plate on machine for Input voltage, I<sub>MAX</sub> and I<sub>EFF</sub>.

**NOTE:** Machine is supplied with a 15AMP 240V 1Phase plug

# Installation set up for MIG with Gas for UNI-MIG MIG180



- (1) Plug Primary power supply cable into 15amp power outlet.
- (2) Select **Standard MIG** using the Standard/Spool Gun selector switch.
- (3) Plug the welding torch into the Euro Mig torch connection socket on the front panel, and tighten it.  
**IMPORTANT** : When connecting the torch be sure to tighten the connection. A loose connection can result in the connector arcing and damaging the machine and gun connector.  
This damage is not covered under warranty.
- (4) Connect earth lead to the workpiece.
- (5) Connect **Gas Line** to **Gas Regulator** and connect the gas regulator to the **Gas Cylinder**.
- (6) Connect the weld power cable plug inside the wire feeder to the output socket **GAS**, and tighten it.
- (7) Place the **Wire Spool** onto the **Spool Holder** - Note: the spool retaining nut is Left Hand thread.  
Snip the wire from the spool being sure to hold the wire to prevent rapid uncoiling. Feed the wire into the wire feeder inlet guide tube through to the drive roller.
- (8) Carefully feed the wire over the drive roller into the outlet guide tube, feed through about 150mm into the torch receptacle. Check that the drive roller being used complies with the wire diameter, replace the roller if necessary.



(6) Connect weld power lead to GAS ⊕ as show in picture inside machine



(7) Place wire onto spool holder - (spool retaining nut is left hand thread ) Feed the wire through the inlet guide tube on to the drive roller.

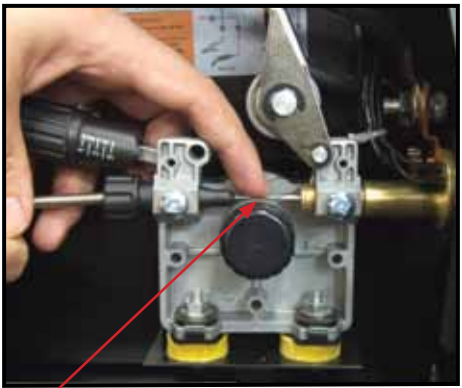

(8) Feed wire over the drive roller into the outlet guide tube, Push the wire through approx 150mm.

## Continued set up for MIG with Gas for UNI-MIG MIG180

- (9) Align the wire into the groove of the drive roller and close down the top roller making sure the wire is in the groove of the bottom drive roller, lock the pressure arm into place.
- (10) Apply a medium amount of pressure to the drive roller.
- (11) Remove the gas nozzle and contact tip from the torch neck,
- (12) Press and hold the trigger on the mig torch until wire is visible at the tip holder
- (13) Fit the correct sized contact tip and feed the wire through it, screw the contact tip into the tip holder of the torch head and nip it up tightly.
- (14) Fit the gas nozzle to the torch head.
- (15) Carefully open the gas cylinder valve and set the flow rate to between 8-12 l/min.
- (16) Set the welding parameters using the wire feed and voltage control knobs.



(9) Close down the top roller bracket and clip the pressure arm into place.



(10) Apply a medium amount of pressure to the drive roller

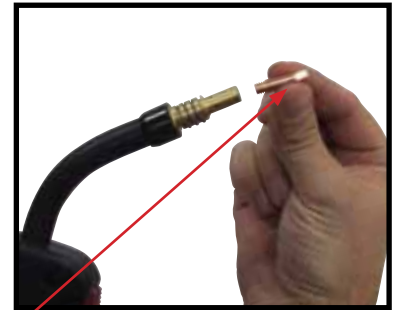

(11) Remove the gas nozzle and contact tip from the front end of the mig torch.



(12) Press and hold the trigger on the mig torch until wire is visible at the tip holder.

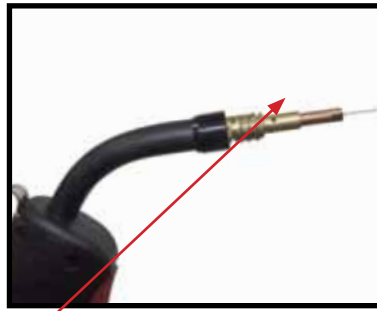

(13) Fit the correct size contact tip over the wire and fasten tightly into the tip holder.



(14) Fit the gas nozzle to the torch head.



(15) Carefully open the valve of the gas cylinder, set the flow to 10 l/min



(16) Set welding parameters using the voltage and wire feed controls.

# Wire Feed Roller Selection



The importance of smooth consistent wire feeding during MIG welding cannot be emphasized enough. Simply put the smoother the wire feed then the better the welding will be.

Feed rollers or drive rollers are used to feed the wire mechanically along the length of the welding gun. Feed rollers are designed to be used for certain types of welding wire and they have different types of grooves machined in them to accommodate the different types of wire. The wire is held in the groove by the top roller of the wire drive unit and is referred to as the pressure roller, pressure is applied by a tension arm that can be adjusted to increase or decrease the pressure as required. The type of wire will determine how much pressure can be applied and what type of drive roller is best suited to obtain optimum wire feed.

**Solid Hard Wire** - like Steel, Stainless Steel require a drive roller with a V shape groove for optimum grip and drive capability. Solid wires can have more tension applied to the wire from the top pressure roller that holds the wire in the groove and the V shape groove is more suited for this. Solid wires are more forgiving to feed due to their higher cross sectional column strength, they are stiffer and don't bend so easy.

**Soft Wire** - like Aluminium requires a U shape groove. Aluminium wire has a lot less column strength, can bend easily and is therefore more difficult to feed. Soft wires can easily buckle at the wire feeder where the wire is fed into inlet guide tube of the torch. The U-shaped roller offers more surface area grip and traction to help feed the softer wire. Softer wires also require less tension from the top pressure roller to avoid deforming the shape of the wire, too much tension will push the wire out of shape and cause it to catch in the contact tip.

**Flux Core / Gasless Wire** - these wires are made up of a thin metal sheath that has fluxing and metal compounds layered onto it and then rolled into a cylinder to form the finished wire. The wire cannot take too much pressure from the top roller as it can be crushed and deformed if too much pressure is applied. A knurled drive roller has been developed and it has small serrations in the groove, the serrations grip the wire and assist to drive it without too much pressure from the top roller. The down side to the knurled wire feed roller on flux cored wire is it will slowly over time bit by bit eat away at the surface of the welding wire, and these small pieces will eventually go down into the liner. This will cause clogging in the liner and added friction that will lead to welding wire feed problems. A U groove wire can also be used for flux core wire without the wire particles coming off the wire surface. However it is considered that the knurled roller will give a more positive feed of flux core wire without any deformation of the wire shape.

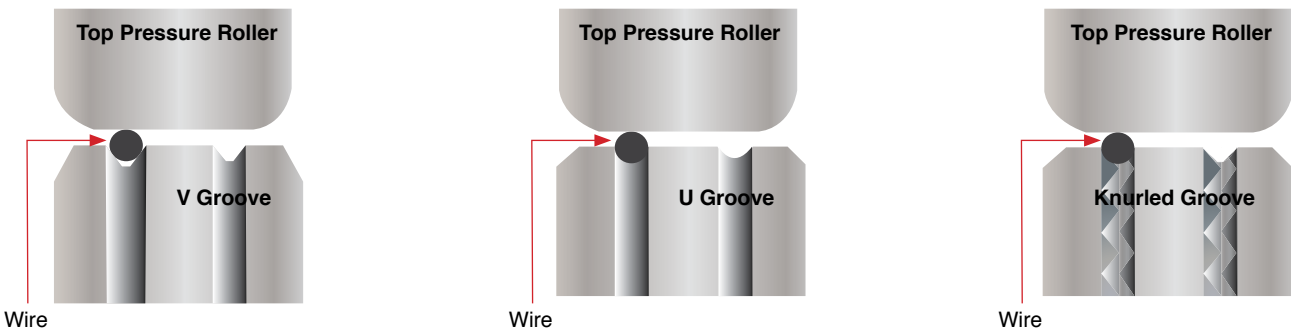

## Drive Rollers

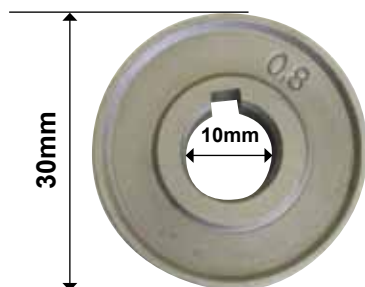

### V Groove Drive Roller - Steel Wire

Part Number	Description
0.6-0.8V30/10	Drive Roll V Groove 0.6-0.8mm

### U Groove Drive Roller - Soft Wire

Part Number	Description
0.8-1.0U30/10	Drive Roll U Groove 0.8-1.0mm
0.9-1.0U30/10	Drive Roll U Groove 0.9-1.0mm

### Knurled Drive Roller - Flux Core Wire

Part Number	Description
0.8-0.9F30/10	Drive Roll V Groove 0.8-0.9mm

## Wire Installation and Set Up Guide

Again the importance of smooth consistent wire feeding during MIG welding cannot be emphasized enough. The correct installation of the wire spool and the wire into the wire feed unit is critical to achieving an even and consistent wire feed. A high percentage of faults with mig welders emanate from poor set up of the wire into the wire feeder. The guide below will assist in the correct setup of your wire feeder.



(1) Remove the spool retaining nut.



(2) Note the tension spring adjuster and spool locating pin.

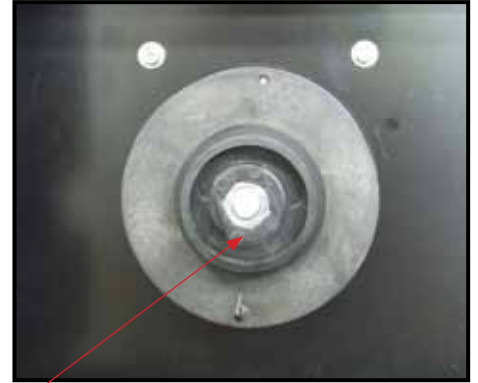

(3) Fit the wire spool onto the spool holder fitting the locating pin into the location hole on the spool. Replace the spool retaining nut tightly



(4) Snip the wire carefully, be sure to hold the wire to prevent the spool uncoiling. Carefully feed the wire into the inlet guide tube of the wire feed unit.

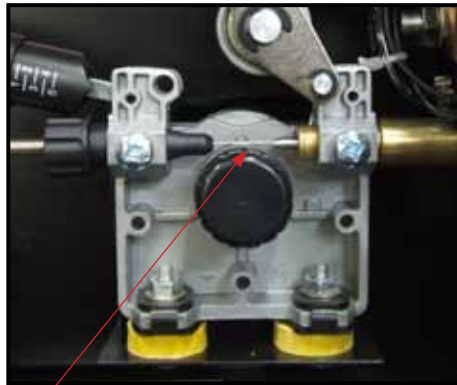

(5) Feed the wire through the drive roller and into the outlet guide tube of the wire feeder.



(6) Lock down the top pressure roller and apply a medium amount of pressure using the tension adjustment knob



(7) Check that the wire passes through the centre of the outlet guide tube without touching the sides.



(8) A simple check for the correct drive tension is to bend the end of the wire over hold it about 100mm from your hand and let it run into your hand, it should coil round in your hand without stopping and slipping at the drive rollers, increase the tension if it slips.  
**• EXTRA CARE SHOULD BE TAKEN WHEN DOING THIS STEP. IF THE WIRE IS NOT BENT OVER IT MAY PIERCE THE GLOVE AND CAUSE SERIOUS INJURY**



(8) The weight and speed of the wire spool turning creates an inertia that can cause the spool to run on and the wire loop over the side of the spool and tangle. if this happens increase the pressure on the tension spring inside the spool holder assembly using the tension adjustment screw.

# Installation set up for MIG with Gasless wire for UNI-MIG MIG180



- (1) Plug Primary power supply cable into 15amp power outlet.
- (2) Select **Standard MIG** using the Standard/Spool Gun selector switch.
- (3) Plug the welding torch into the Euro Mig torch connection socket on the front panel, and tighten it.  
**IMPORTANT** : When connecting the torch be sure to tighten the connection. A loose connection can result in the connector arcing and damaging the machine and gun connector.  
 This damage is not covered under warranty.
- (4) Connect earth lead to the workpiece.
- (5) Connect the weld power cable plug inside the wire feeder to the output socket **NO GAS**, and tighten it.
- (6) Fit the correct sized Knurled Drive roller for Gas Less Flux Cored wire
- (7) Place the **Wire Spool** onto the **Spool Holder** - Note: the spool retaining nut is Left Hand thread. Snip the wire from the spool being sure to hold the wire to prevent rapid uncoiling. Feed the wire into the wire feeder inlet guide tube through to the drive roller.



(5) Connect weld power lead to NO GAS  as show in picture inside machine

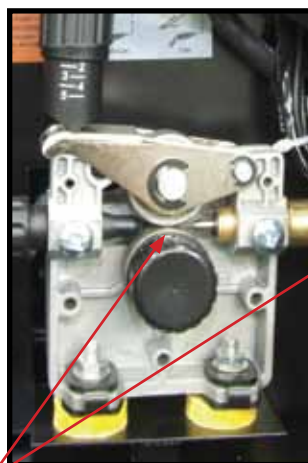

(7) Fit the correct sized Knurled Drive roller for Gas Less Flux Cored wire



(7) Place wire onto spool holder - (spool retaining nut is left hand thread ) Feed the wire through the inlet guide tube on to the drive roller.

## Continued set up for MIG with Gasless wire for UNI-MIG MIG180

- (8) Carefully feed the wire over the drive roller into the outlet guide tube, feed through about 150mm into the torch receptacle. Check that the drive roller being used complies with the wire diameter, replace the roller if necessary.
- (9) Align the wire into the groove of the drive roller and close down the top roller making sure the wire is in the groove of the bottom drive roller, lock the pressure arm into place.
- (10) Apply a medium amount of pressure to the drive roller.
- (11) Remove the gas nozzle and contact tip from the torch neck,
- (12) Press and hold the trigger on the mig torch until wire is visible at the tip holder
- (13) Fit the correct sized contact tip and feed the wire through it, screw the contact tip into the tip holder of the torch head and nip it up tightly.
- (14) Fit the gas nozzle to the torch head.
- (15) Set the welding parameters using the wire feed and voltage control knobs.



(8) Feed wire over the drive roller into the outlet guide tube, Push the wire through approx 150mm. Use a Knurled Drive Roller of the correct size



(9) Close down the top roller bracket and clip the pressure arm into place.

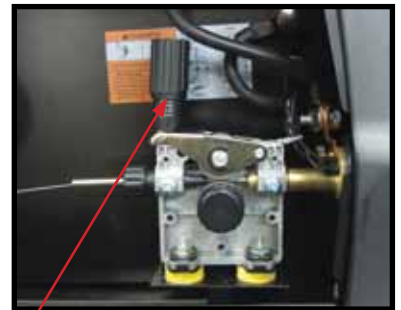

(10) Apply a medium amount of pressure to the drive roller

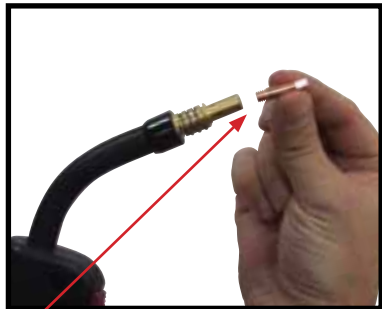

(11) Remove the gas nozzle and contact tip from the front end of the mig torch.



(12) Press and hold the inch wire button to feed the wire down the torch cable through to the torch head.



(13) Fit the correct size contact tip over the wire and fasten tightly into the tip holder.



(14) Fit the gas nozzle to the torch head.



(15) Set welding parameters using the voltage and wire feed controls.



## Mig Torch Liner Installation



- (1) Lay the torch out straight on the ground and remove the front end parts
- (2) Remove the liner retaining nut.
- (3) Carefully pull the liner out of the torch cable assembly
- (4) Select the correct new liner and carefully unravel avoiding putting any kinks in the liner, if you kink the liner it will make it no good and will require replacement.
- (5) Carefully and slowly feed the liner in short forward movements down the cable assembly all the way through and out the torch neck end. Avoid kinking the liner, kinking liner it will make it no good and require replacement.
- (6) Fit the liner retaining nut and screw down only 1/2 way
- (7) Leaving the torch straight snip the liner approximately 3mm past the end of the torch neck
- (8) Place the tip holder over the end of the liner and screw into the torch neck nipping it up tight.
- (9) Screw down the liner nut the remaining 1/2 and nip it up tight. This method compresses the liner inside the torch cable assembly preventing it moving during use and ensures good wire feed.

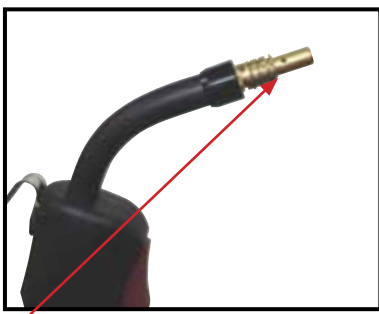

(1) Remove mig torch front end parts

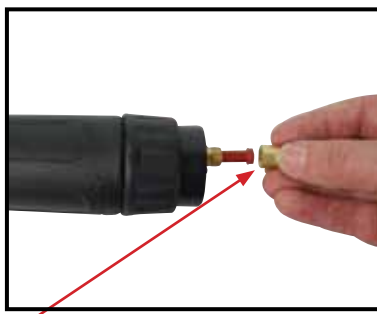

(2) Remove the liner retaining nut

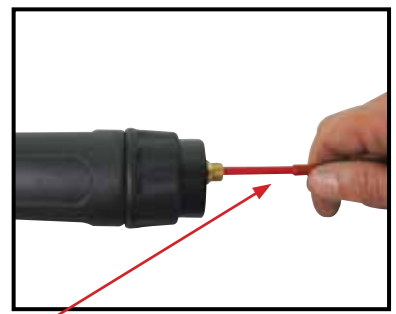

(3) Carefully pull out and completely remove the liner

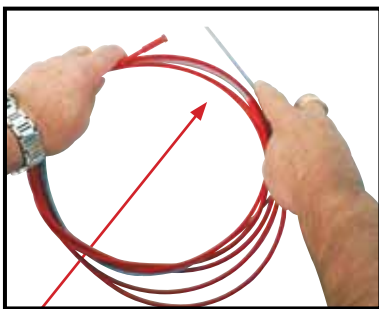

(4) Carefully unravel the new liner

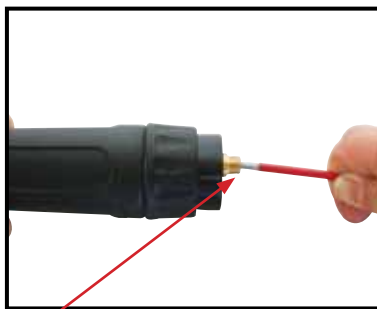

(5) Carefully feed in the new liner down the torch lead all the way to exit the torch neck.

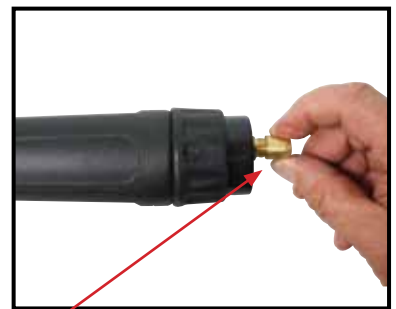

(6) Fit the liner retaining nut and screw only 1/2 way down



(7) Snip the liner off 3mm past the end of the torch neck.

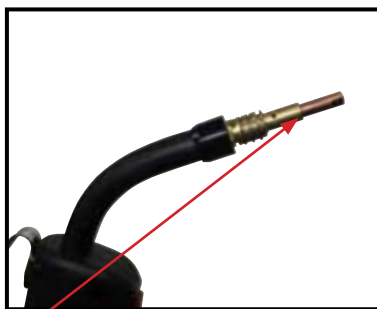

(8) Replace the front end parts

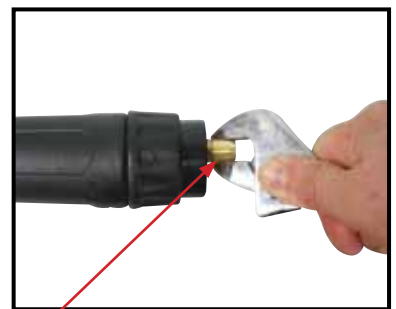

(9) Fully screw down the liner retaining nut and nip it up tight.

## Torch & Wire Feed Set Up for Aluminium Wire

- (1) Lay the torch out straight on the ground and remove the front end parts
- (2) Remove the liner retaining nut.
- (3) Carefully pull the liner out of the torch cable assembly
- (4) Select a Teflon liner, carefully and slowly feed the liner in short forward movements down the cable assembly all the way through and out the torch neck end. Avoid kinking the liner, kinking the liner will ruin it and require replacement.
- (5) Leave the liner extending out the end of the torch neck end by 3mm.
- (5) Fit the liner retaining collet together with the liner o-ring.
- (8) Push the liner firmly into the torch lead and tighten the liner retaining nut.
- (9) Install a U groove drive roller of the correct size to match the wire diameter being used.

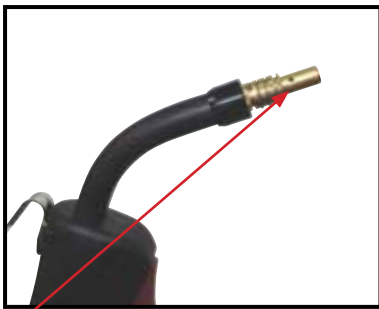

(1) Remove mig torch front end parts

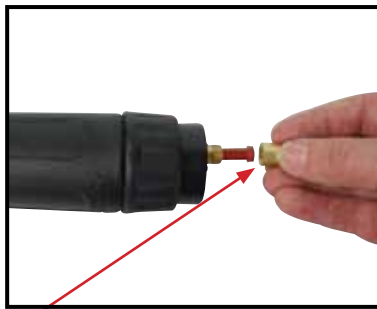

(2) Remove the liner retaining nut

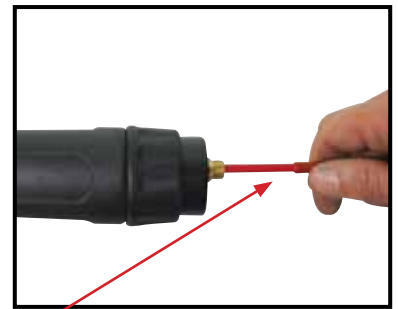

(3) Carefully pull out and completely remove the liner

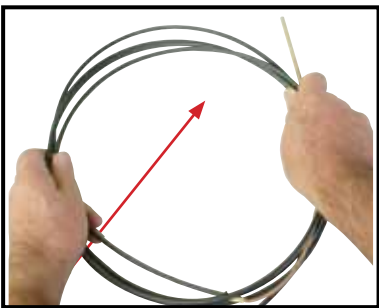

(4) Carefully unravel the new liner

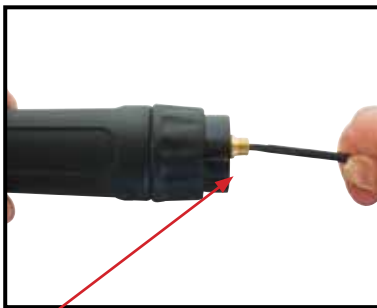

(5) Carefully feed in the new liner in short forward movements down the torch lead all the way to exit the torch neck. Be careful not to kink the liner

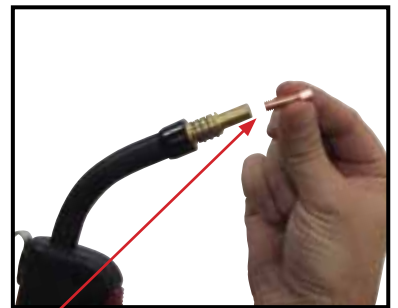

(6) Replace the front end parts

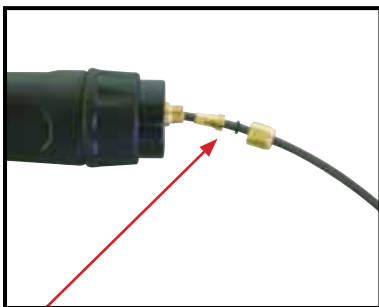

(7) Fit the liner collet, liner O-ring and liner retaining nut.

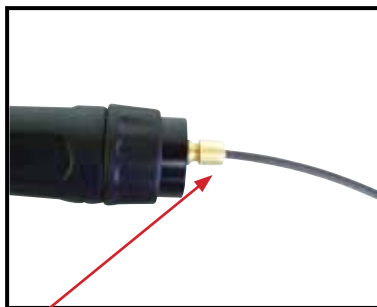

(8) Push the liner firmly into the torch lead and tighten the liner retaining nut

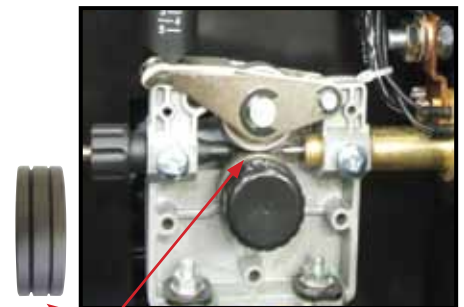

(9) Install a U groove drive roller of the correct size for the diameter wire being used.

## Continued Torch & Wire Feed Set Up for Aluminium Wire



- (10) Remove circlip from guide tube.
- (11) Remove the inlet guide tube from the front end machine euro connector using long nose pliers.
- (12) Carefully feed the extended PA liner section into the inlet guide tube hole of the machine euro connector
- (13) Feed the extended PA liner all the way up and over the drive roller
- (14) Tighten the torch euro connection to the machine euro connector
- (15) Cut the extended liner with a sharp Stanley knife just in front of the drive roller
- (16) Fit an Aluminium contact tip of the correct size to match the diameter of the wire being used
- (17) Fit the remaining front end parts to the torch neck ready for welding

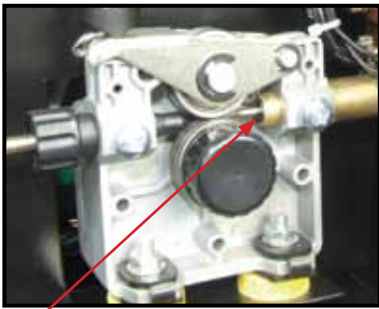

(10) Remove circlip from guide tube.



(11) Remove the inlet guide tube using long nose pliers.



(12) Carefully feed the PA liner into the inlet guide tube hole of the torch euro receptacle

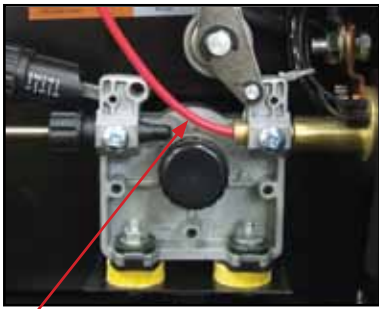

(13) Take the extended PA liner all the way up and over the drive roller



(14) Tighten and secure the torch euro connector to the machine euro receptacle

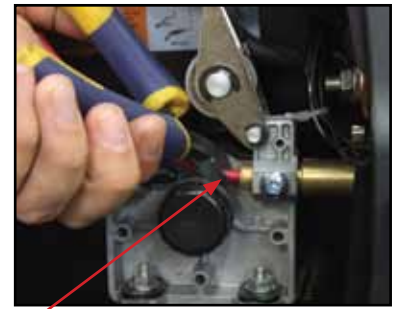

(15) Cut the extended PA liner with a sharp Stanley knife just in front of the drive roller

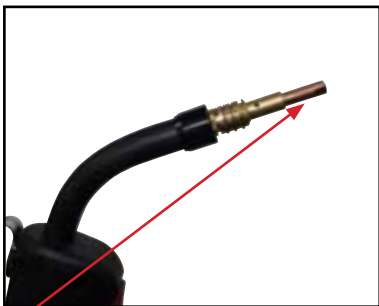

(16) Fit an Aluminium contact tip of the correct size to match the wire diameter being used

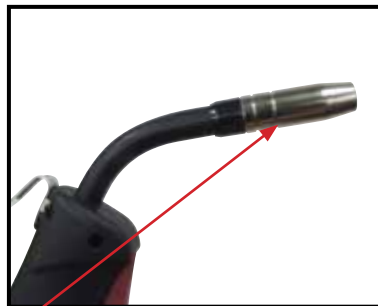

(17) Fit the remaining front end parts to the torch neck ready for welding.

## Installation set up of the Spool Gun for UNI-MIG MIG180

- (1) Plug Primary power supply cable into 15amp power outlet.
- (2) Switch on the machine,
- (3) Select **Spool Gun** using the Standard/Spool Gun selector switch.
- (4) Connect the Spool Gun to the Euro Mig torch connection socket on the front panel, and tighten it. Connect the Spool Gun control cable to the receptacle and tighten it.  
**IMPORTANT** : When connecting the torch be sure to tighten the connection. A loose connection can result in the connector arcing and damaging the machine and gun connector. This damage is not covered under warranty.
- (5) Connect earth lead to the workpiece.
- (6) Connect **Gas Line** to **Gas Regulator** and connect the gas regulator to the **Gas Cylinder**.
- (7) Connect weld power lead to GAS ⊕ Remove wire from the drive unit as show in picture inside machine
- (8) Take the Spool Gun and remove the spool cover.
- (9) Place the **Wire Spool** onto the **Spool Holder** - Hold and snip the wire from the spool being sure to hold the wire to prevent rapid uncoiling.

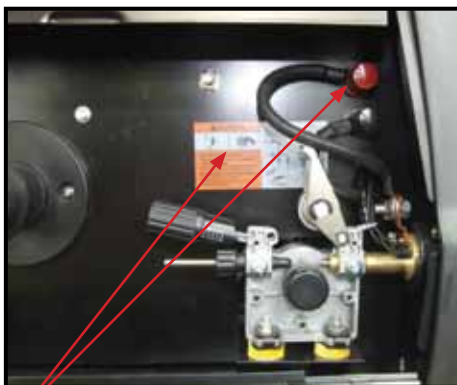

(7) Connect weld power lead to GAS ⊕ Remove wire from the drive unit as show in picture inside machine

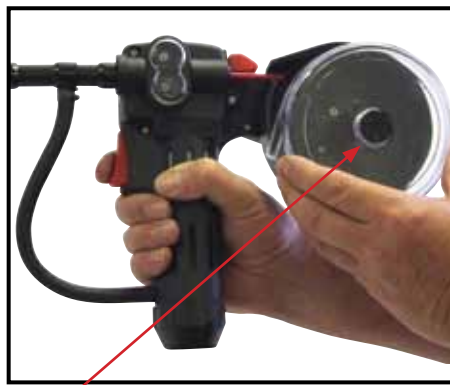

(8) Remove the spool cover by unscrewing the retaining nut and lifting off the cover



(9) Place a spool of wire onto the Spool holder.

## Continued set up of the Spool Gun for UNI-MIG MIG180



- (10) Carefully feed the wire through the red guide tube into meet the drive roller. Push down the tension arm adjustment lever to release the drive roll pressure allowing the wire to be guided through the drive rollers into the gun neck.
- (11) Replace the spool cover
- (12) Remove the gas nozzle and contact tip from the torch neck, Pull the trigger to drive the wire through the neck until it exits the contact tip holder.
- (13) Fit the correct sized contact tip by feeding the wire through it, screw the contact tip into the tip holder of the torch neck and nip it up tightly.
- (14) Check the drive roll pressure is enough to drive the wire smoothly and adjust the drive roll pressure if required by using the adjusting screw at the top of the torch body. Do not apply too much pressure.
- (15) Fit the gas nozzle to the torch head.
- (16) Carefully open the gas cylinder valve and set the flow rate to between 8-12 l/min.
- (17) Set the welding parameters using the wire feed and voltage control knobs.

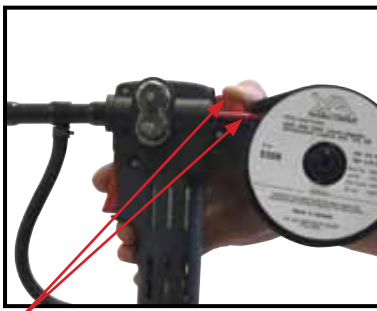

(10) Carefully feed the wire through the inlet guide tube onto the drive roller through into the outlet guide tube. Push down the tension arm lever to release the pressure of the drive roller allowing the wire to be guided through the drive roller into the gun neck.

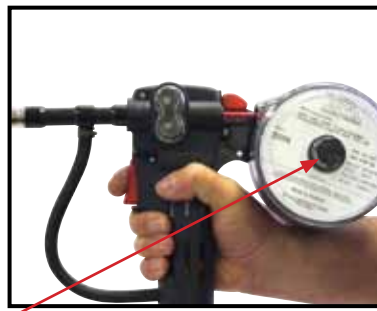

(11) Replace the Spool Cover.

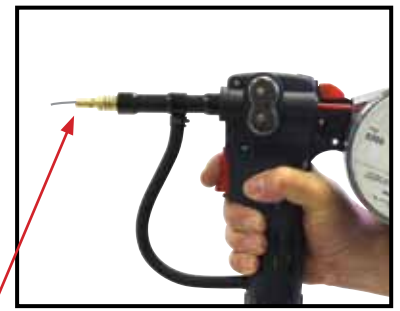

(12) Remove the gas nozzle and contact tip. Pull the trigger to drive the wire through the neck until it exits the contact tip holder



(13) Fit the contact tip over the wire and screw it into the tip holder, nip it up tight.



(14) Adjust the drive roll pressure if required by using the adjusting screw at the top of the torch.



(15) Fit the gas nozzle ready for welding.



(16) Carefully open the valve of the gas cylinder, set the flow to 8-12 l/min



(17) Set welding parameters using the voltage and wire feed controls.

## MIG (Metal Inert Gas) Welding

**Definition of MIG Welding** - MIG (metal inert gas) welding also known as GMAW (gas metal arc welding) or MAG (metal active gas welding), is a semi-automatic or automatic arc welding process in which a continuous and consumable wire electrode and a shielding gas are fed through a welding gun. A constant voltage, direct current power source is most commonly used with MIG welding. There are four primary methods of metal transfer in MIG welding, called short circuit (also known as dip transfer) globular transfer, spray transfer and pulsed-spray, each of which has distinct properties and corresponding advantages and limitations. To perform MIG welding, the basic necessary equipment is a welding gun, a wire feed unit, a welding power supply, an electrode wire, and a shielding gas supply. Short circuit transfer is the most common used method whereby the wire electrode is fed continuously down the welding torch through to and exiting the contact tip. The wire touches the work piece and causes a short circuit the wire heats up and begins to form a molten bead, the bead separates from the end of the wire and forms a droplet that is transferred into the weld pool. This process is repeated about 100 times per second, making the arc appear constant to the human eye.

### MIG Circuit Diagram

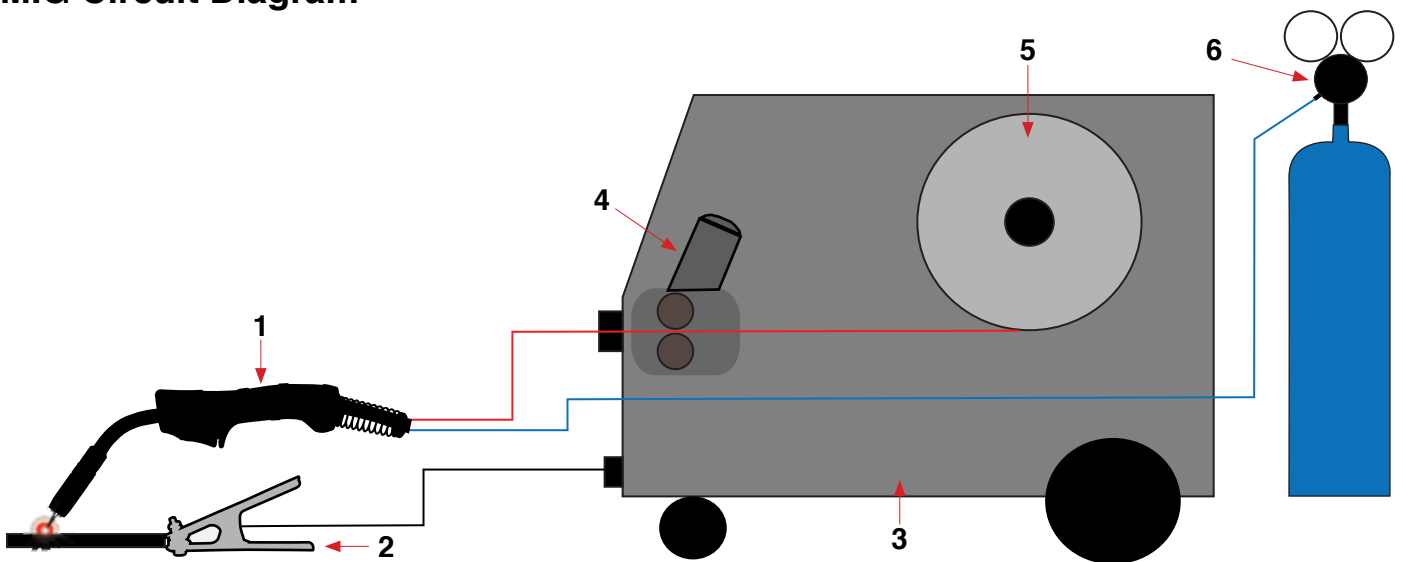

1. Mig Torch - 2. Work Piece - 3. Power Source - 4. Wire Feeder - 5. Wire Spool - 6. Gas

## MIG (Metal Inert Gas) Welding

**Short Circuit Transfer** - Short circuit transfer is the most common used method whereby the wire electrode is fed continuously down the welding torch through to and exiting the contact tip. The wire touches the work piece and causes a short circuit the wire heats up and begins to form a molten bead, the bead separates from the end of the wire and forms a droplet that is transferred into the weld pool. This process is repeated about 100 times per second, making the arc appear constant to the human eye.

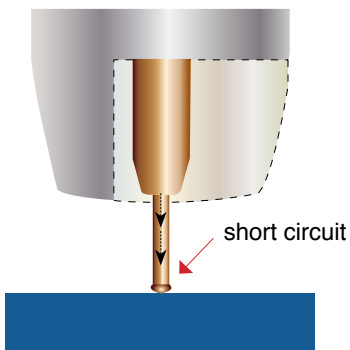

The wire approaches the work piece and touches the work creating a short circuit between the wire and the base metal, because there is no space between the wire and the base metal there is no arc and current flows through the wire.

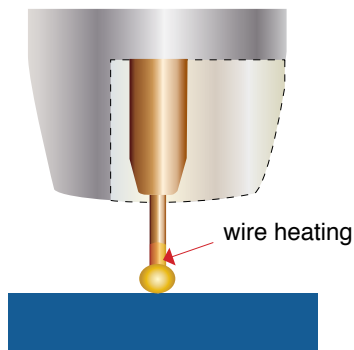

The wire cannot support all the current flow, resistance builds up and the wire becomes hot and weak and begins to melt

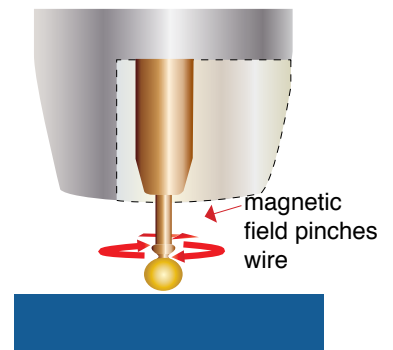

The current flow creates a magnetic field that begins to pinch the melting wire forming it into droplet

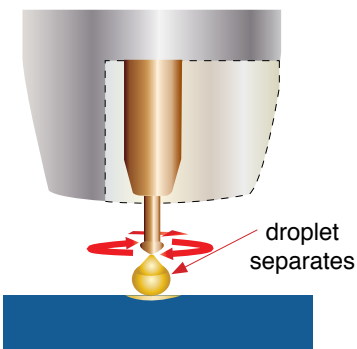

The pinch causes the forming droplet to separate and fall towards the now creating weld pool.

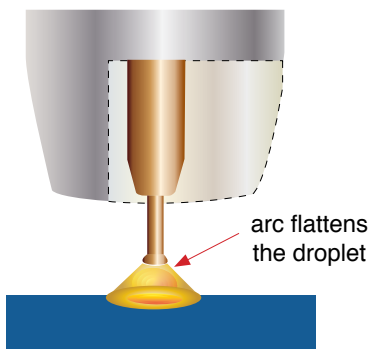

An arc is created at the separation of the droplet and the heat and force of the arc flattens out the droplet into the weld pool. The heat of the arc melts the end of the wire slightly as it feeds towards the base metal

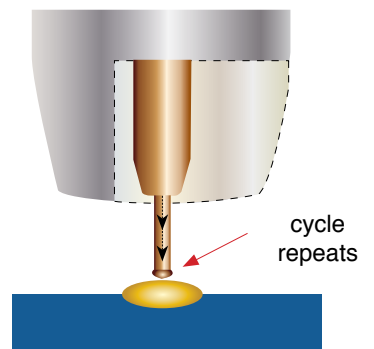

The wire feed speed overcomes the heat of the arc and the wire again approaches the work to short circuit and repeat the cycle.

# Basic MIG Welding .

Good weld quality and weld profile depends on gun angle, direction of travel, electrode extension (stick out), travel speed, thickness of base metal, wire feed speed (amperage) and arc voltage. To follow are some basic guides to assist with your setup.

## Gun Position - Travel Direction, Work Angle

Gun position or technique usually refers to how the wire is directed at the base metal, the angle and travel direction chosen. Travel speed and work angle will determine the characteristic of the weld bead profile and degree of weld penetration.

**Push Technique** - The wire is located at the leading edge of the weld pool and pushed towards the un-melted work surface. This technique offers a better view of the weld joint and direction of the wire into the weld joint. Push technique directs the heat away from the weld puddle allowing faster travel speeds providing a flatter weld profile with light penetration - useful for welding thin materials. The welds are wider and flatter allowing for minimal clean up / grinding time.

**Perpendicular Technique** - The wire is fed directly into the weld, this technique is used primarily for automated situations or when conditions make it necessary. The weld profile is generally higher and a deeper penetration is achieved.

**Drag Technique** - The gun and wire is dragged away from the weld bead. The arc and heat is concentrated on the weld pool, the base metal receives more heat, deeper melting, more penetration and the weld profile is higher with more build up.

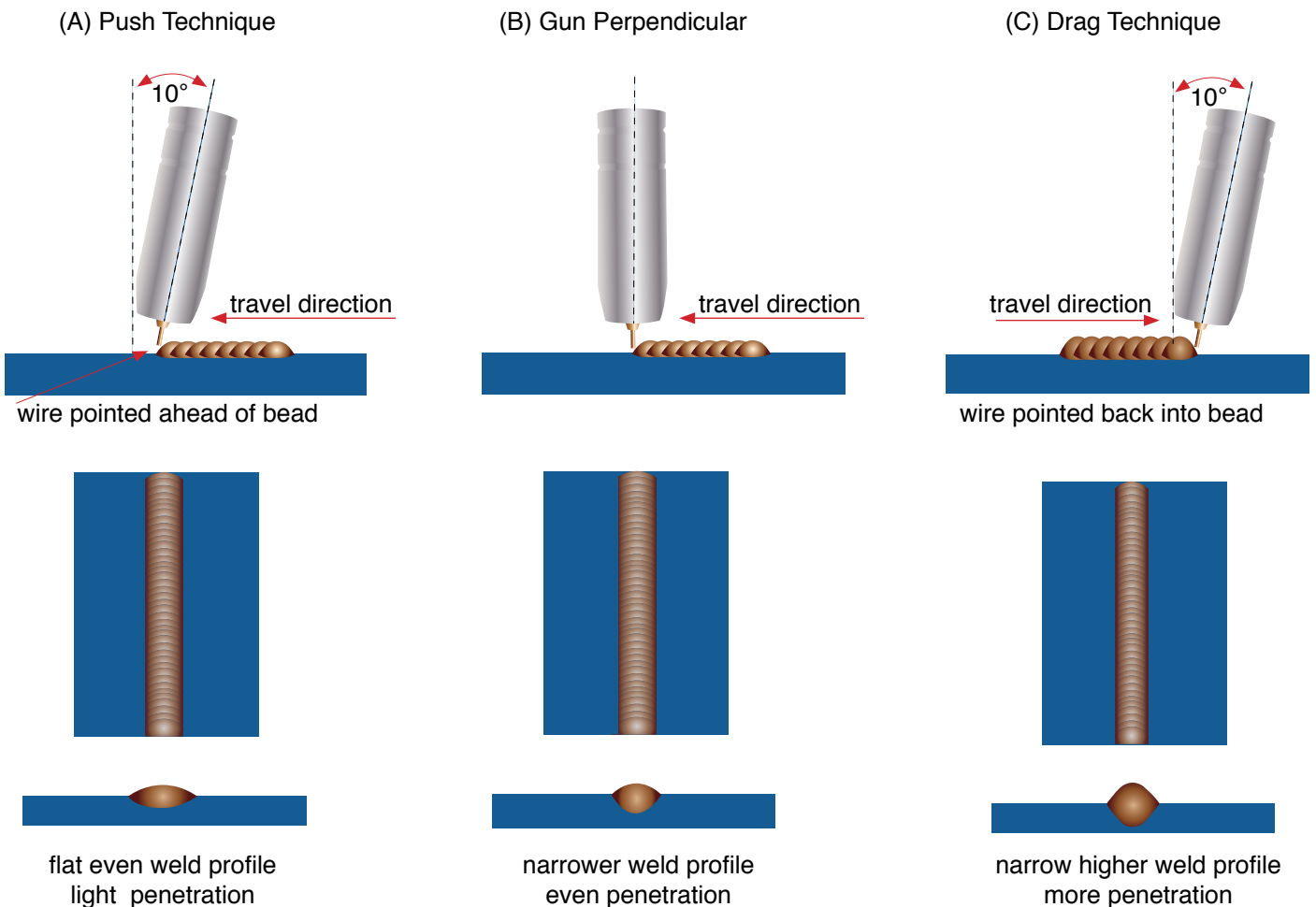



**Travel Angle** - Travel angle is the right to left angle relative to the direction of welding. A travel angle of 5° - 15° is ideal and produces a good level of control over the weld pool. A travel angle greater than 20° will give an unstable arc condition with poor weld metal transfer, less penetration, high levels of spatter, poor gas shield and poor quality finished weld.

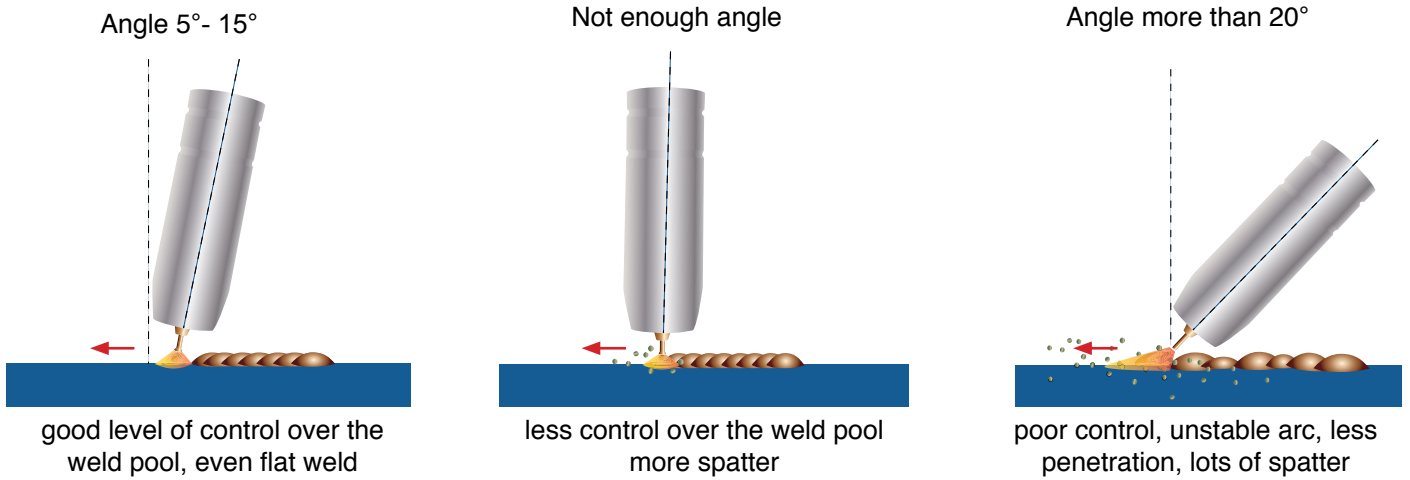

**Angle to Work** - The work angle is the forward back angle of the gun relative to the work piece. The correct work angle provides good bead shape, prevents undercut, uneven penetration, poor gas shield and poor quality finished weld.

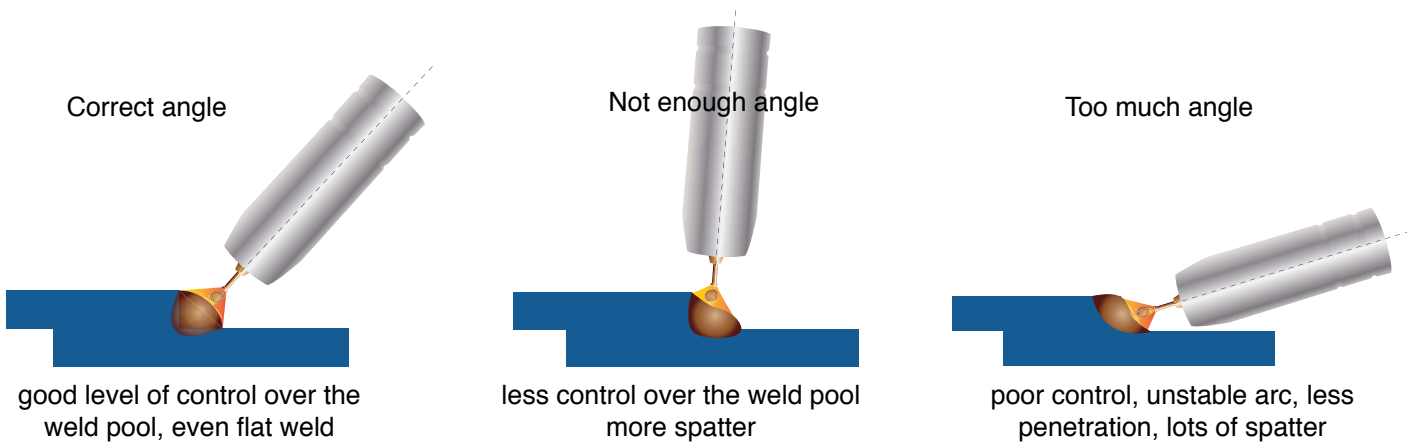

**Stick Out**- Stick out is the length of the unmelting wire protruding from the end of the contact tip. A constant even stick out of 5-10mm will produce a stable arc, and an even current flow providing good penetration and even fusion. Too short stick out will cause an unstable weld pool, produce spatter and over heat the contact tip. Too long stick out will cause an unstable arc, lack of penetration, lack of fusion and increased spatter.

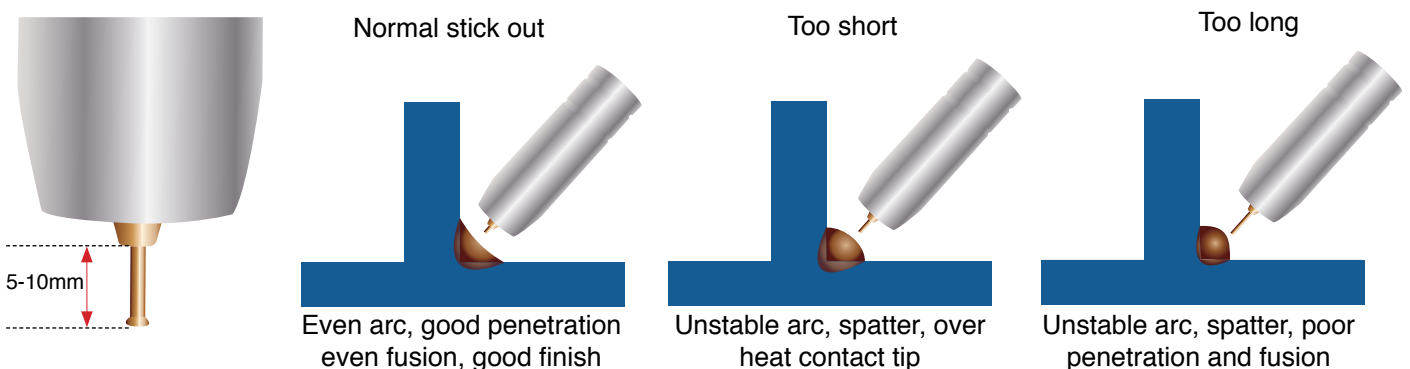

**Travel Speed** - Travel speed is the rate that the gun is moved along the weld joint and is usually measured in mm per minute. Travel speeds can vary depending on conditions and the welders skill and is limited to the welders ability to control the weld pool. Push technique allows faster travel speeds than Drag technique. Gas flow must also correspond with the travel speed, increasing with faster travel speed and decreasing with slower speed. Travel speed needs to match the amperage and will decrease as the material thickness and amperage increase.

**Too Fast Travel Speed** - A too fast travel speed produces too little heat per mm of travel resulting in less penetration and reduced weld fusion, the weld bead solidifies very quickly trapping gases inside the weld metal causing porosity. Undercutting of the base metal can also occur and an unfilled groove in the base metal is created when the travel speed is too fast to allow molten metal to flow into the weld crater created by the arc heat.

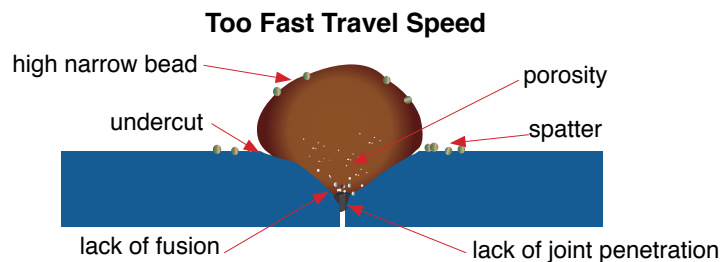

**Too Slow Travel Speed** - A too slow travel speed produces a large weld with lack of penetration and fusion. The energy from the arc dwells on top of the weld pool rather than penetrating the base metal. This produces a wider weld bead with more deposited weld metal per mm than is required resulting in a weld deposit of poor quality.

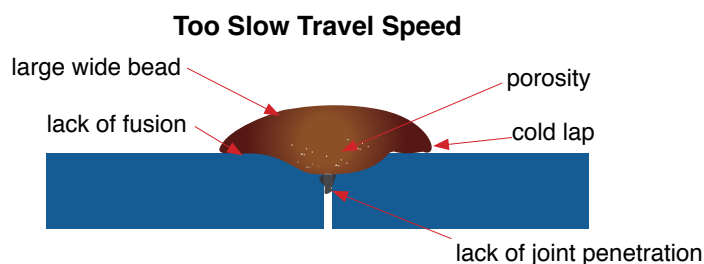

**Correct Travel Speed** - The correct travel speed keeps the arc at the leading edge of the weld pool allowing the base metal to melt sufficiently to create good penetration, fusion and wetting out of the weld pool producing a weld deposit of good quality.

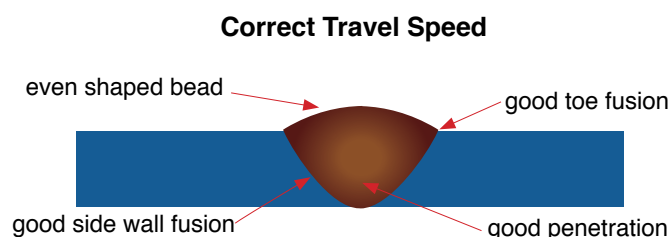

**Wire types and sizes** - Use the correct wire type for the base metal being welded. Use stainless steel wire for stainless steel, aluminium wires for aluminium and steel wires for steel.

Use a smaller diameter wire for thin base metals. For thicker materials use a larger wire diameter and larger machine, check the recommended welding capability of your machine.

As a guide refer to the “Welding Wire Thickness Chart” below.

WELDING WIRE DIAMETER CHART							
MATERIAL THICKNESS	RECOMMENDED WIRE DIAMETERS						
	MIG SOLID WIRE				GASLESS FLUX CORED WIRE		
	0.6mm	0.8mm	0.9mm	1.0mm	0.8mm	0.9mm	1.2mm
24 Gauge (.60mm)	Yellow						
22 Gauge (.75mm)	Yellow	Yellow			Yellow		
20 Gauge (.90mm)	Yellow	Yellow			Yellow	Yellow	
18 Gauge (1.0mm)	Yellow	Yellow	Yellow		Yellow	Yellow	
16 Gauge (1.2mm)		Yellow	Yellow		Yellow	Yellow	Yellow
14 Gauge (1.9mm)		Yellow	Yellow	Yellow	Yellow	Yellow	Yellow
3.0mm		Yellow	Yellow	Yellow		Yellow	Yellow
5.0mm			Yellow	Yellow		Yellow	Yellow
6.0mm			Yellow	Yellow			Yellow
8.0mm			Yellow	Yellow			Yellow
10.mm				Yellow			Yellow
12.0mm				Yellow			

For material thickness of 5.0mm and greater, multi-pass runs or a beveled joint design may be required depending on the amperage capability of your machine.

**Gas selection** - The purpose of the gas in the MIG process is to protect / shield the wire, the arc and the molten weld metal from the atmosphere. Most metals when heated to a molten state will react with the air in the atmosphere, without the protection of the shielding gas the weld produced would contain defects like porosity, lack of fusion and slag inclusions. Additionally some of the gas becomes ionised (electrically charged) and helps the current flow smoothly.

The correct gas flow is also very important in protecting the welding zone from the atmosphere. Too low flow will give inadequate coverage and result in weld defects and unstable arc conditions. Too high flow can cause air to be drawn into the gas column and contaminate the weld zone.

Use the correct shielding gas. Co2 is good for steel and offers good penetration characteristics, the weld profile is narrower and slightly more raised than the weld profile obtained from Argon Co2 mixed gas. Argon Co2 mix gas offers better weld ability for thin metals and has a wider range of setting tolerance on the machine. Argon 80% Co2 20% is a good all round mix suitable for most applications.

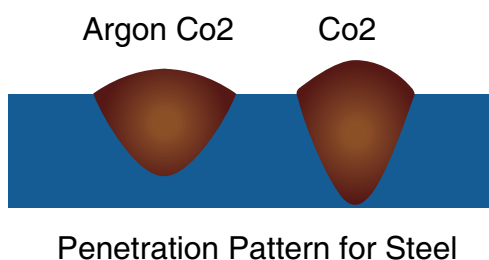

# SB15 MIG TORCH

## 180A AIR COOLED MIG WELDING TORCH

Rating: 180A CO<sup>2</sup> 150A mixed gas EN60974-7 @ 60% duty cycle. 0.8 to 1.2mm wires

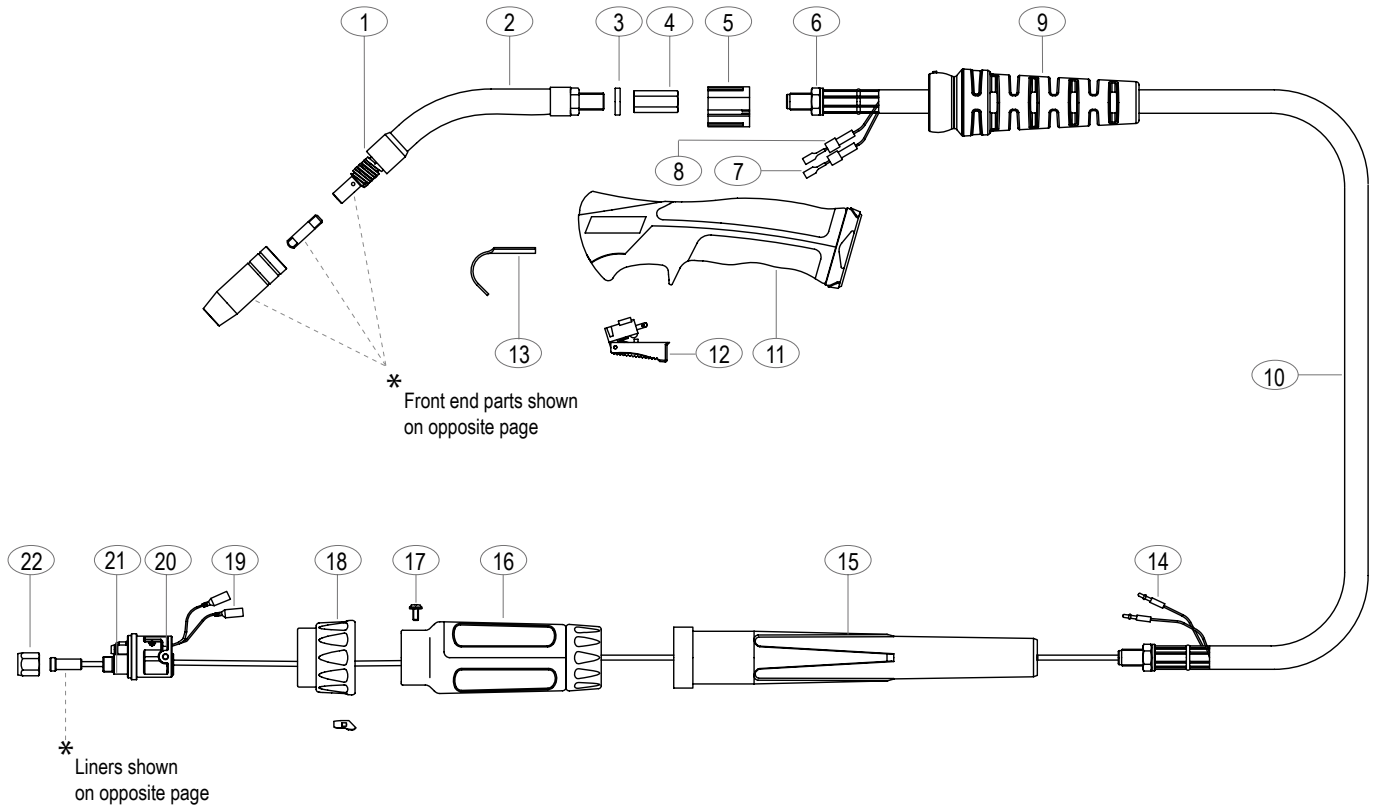

Torch Model	Description			
	<b>Part Number</b>	<b>3 Mt</b>	<b>4 Mt</b>	<b>5 Mt</b>
SB Suregrip Ergo Torch Package	SB15-3	SB15-4	SB15-5	

### Spare Parts

Part Number	Description
2	SNK15 Swan Neck (Suit SB15)
	SNK195 Swan Neck Suit Procraft 195 / BP15 Torch
	SNKF15 Flexible Swan Neck (Suit SB15)
11	BZLH Ergo handle complete with Trigger (Suit SB15)
12	BX0020 Trigger



**PLEASE NOTE:**  
Torch shown above is the recommended replacement torch for this machine

These parts are manufactured in China and are offered as replacement parts suitable for "BINZEL" style torches.

# SB15 MIG TORCH

## Front end consumables

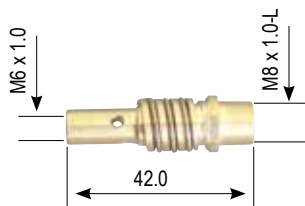
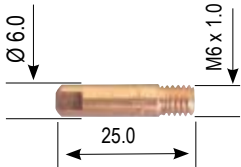

## Liners



### SB15 Contact Tips

Part Number	Description
PCT0008-06	Contact Tip Steel (0.6mm)
PCT0008-08	Contact Tip Steel (0.8mm)
PCT0008-09	Contact Tip Steel (0.9mm)
PCT0008-10	Contact Tip Steel (1.0mm)
PCTAL0008-09	Contact Tip Aluminium (0.9mm)
PCTAL0008-10	Contact Tip Aluminium (1.0mm)

### SB15 Tip Holder

Part Number	Description
PCTH15	Contact Tip Holder (Suit SB15)
PCTH195	Contact Tip Holder Suit Procraft 195 / BP15 Torch
PGNS15	Shroud Spring

### SB15 Gas Nozzle

Part Number	Description
PGN15CYL	Cylindrical Nozzle
PGN15CON	Conical Nozzle
PGN15TAP	Tapered Nozzle
PGN15SPOT	Spot Nozzle

### SB15 Liners

Part Number	Description
SLB3M	Blue Steel Liner 3 Metre
SLB4M	Blue Steel Liner 4 Metre
SLB5M	Blue Steel Liner 5 Metre
SLR3M	Red Steel Liner 3 Metre
SLR4M	Red Steel Liner 4 Metre
SLR5M	Red Steel Liner 5 Metre
TLB3M	Blue Aluminium Liner 3 Metre
TLB4M	Blue Aluminium Liner 4 Metre
TLR3M	Red Aluminium Liner 3 Metre
TLR4M	Red Aluminium Liner 4 Metre
NKSTL	Neck Spring for Aluminium (Suit SB15)

These parts are manufactured in China and are offered as replacement parts suitable for "BINZEL" style torches.

# 135 AMP SPOOL GUN

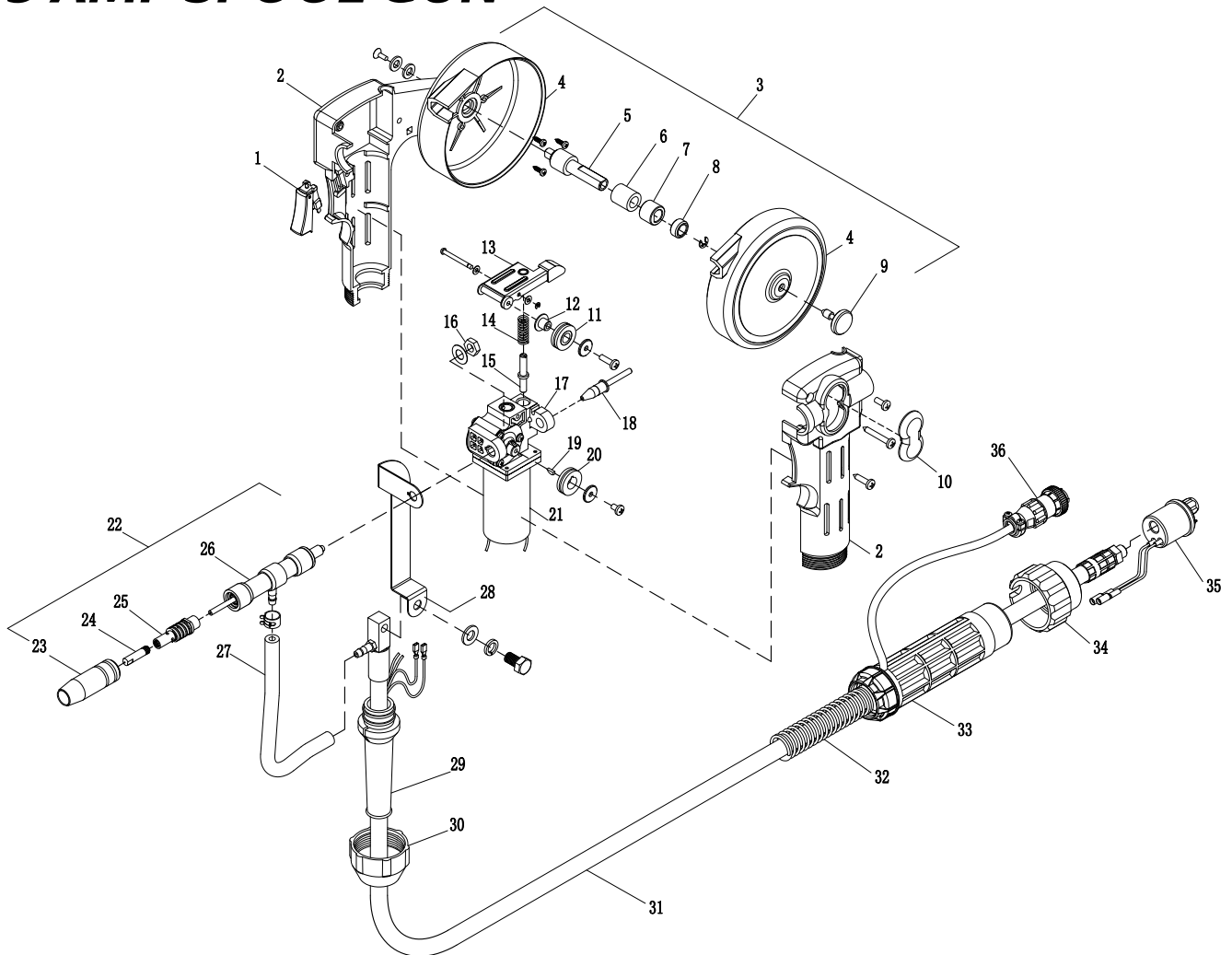

**Torch Model**

Description	Part Number
XcelArc Spool Gun SPG135 x 6m	SPG135

**Spare Parts**

Part Number	Description	Part Number	Description		
1	LGJ2003	Trigger	19	LGX2018	Key
2	LMH2001	Handle	20	LGX2019U	DriveRoll U Groove 0.8-0.9mm
3	LMT2001	Spool Cover Total Assembly	21	LZ3603	Motor
4	LMT2016	Spool Cover Shell	22	LYFE1001	Gun Neck
5	LMT2015	Spool Shaft	23	SEE PAGE 41	Gas Nozzle
6	LMT2014	Rubber Resistance Bush	24	SEE PAGE 41	Contact Tip
7	LMT2013	Locating Bush	25	SEE PAGE 41	Diffuser Tip Holder with Spring
8	LMT2012	Adjusting Nut	26	LYFE1011	Gun Neck Body
9	LMT2011	Locking Screw	27	LW0101	Gas Hose
10	LGH2011	Drive Roll Cover	28	LGK2011	Conducting Board
11	LGX2016U	Pressure Roll U Groove 0.8-0.9mm	29	LYH1012	Cable Support
12	LGX2015	Bearing	30	LYH1013	Handle Nut
13	LGX2014	Pressure Arm with Shaft	31	LYL1640	Cable Assembly 4m
14	LGX2012	Pressure Arm Spring	32	ES2001	Cable Support Spring
15	LGX2011	Pressure Arm Bolt	33	EH2201	Cable Support Cover
16	LGF2111	Nut	34	EP3001	Euro Connector Nut
17	LX1040	Gear Box Assembly	35	LTU2202	Euro Connector Plug
18	LMX2011	Inlet Guide	36	LMV0004	4 Pin Plug

# 135 AMP SPOOL GUN



## Front end consumables

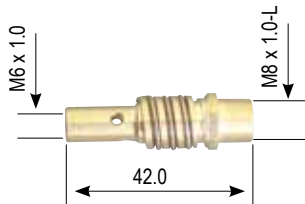
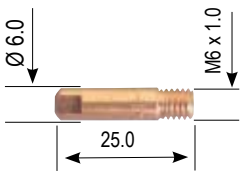

### SB15 Contact Tips

Part Number	Description
PCT0008-06	Contact Tip Steel (0.6mm)
PCT0008-08	Contact Tip Steel (0.8mm)
PCT0008-09	Contact Tip Steel (0.9mm)
PCT0008-10	Contact Tip Steel (1.0mm)
PCTAL0008-09	Contact Tip Aluminium (0.9mm)
PCTAL0008-10	Contact Tip Aluminium (1.0mm)

### SB15 Tip Holder

Part Number	Description
PCTH15	Contact Tip Holder (Suit SB15)
PCTH195	Contact Tip Holder Suit Procraft 195 / BP15 Torch

### SB15 Gas Nozzle

Part Number	Description
PGN15CYL	Cylindrical Nozzle
PGN15CON	Conical Nozzle
PGN15TAP	Tapered Nozzle

# MIG WELDING TROUBLE SHOOTING

The following chart addresses some of the common problems of MIG welding. In all cases of equipment malfunction, the manufacturer's recommendations should be strictly adhered to and followed.

<b>1: Excessive Spatter</b>	
<b>Possible Reason</b>	<b>Suggested Remedy</b>
Wire feed speed set too high	Select lower wire feed speed
Voltage too high	Select a lower voltage setting
Wrong polarity set	select the correct polarity for the wire being used - see machine setup guide
Stick out too long	Bring the torch closer to the work
Contaminated base metal	Remove materials like paint, grease, oil, and dirt, including mill scale from base metal
Contaminated mig wire	Use clean dry rust free wire. Do not lubricate the wire with oil, grease etc
Inadequate gas flow or too much gas flow	Check the gas is connected, check hoses, gas valve and torch are not restricted. Set the gas flow between 6-12 l/min flow rate. Check hoses and fittings for holes, leaks etc Protect the welding zone from wind and drafts
<b>2: Porosity - small cavities or holes resulting from gas pockets in weld metal.</b>	
<b>Possible Reason</b>	<b>Suggested Remedy</b>
Wrong gas	Check that the correct gas is being used
Inadequate gas flow or too much gas flow	Check the gas is connected, check hoses, gas valve and torch are not restricted. Set the gas flow between 10 - 15 l/min flow rate. Check hoses and fittings for holes, leaks etc. Protect the welding zone from wind and drafts
Moisture on the base metal	Remove all moisture from base metal before welding
Contaminated base metal	Remove materials like paint, grease, oil, and dirt, including mill scale from base metal
Contaminated mig wire	Use clean dry rust free wire. Do not lubricate the wire with oil, grease etc
Gas nozzle clogged with spatter, worn or out of shape	Clean or replace the gas nozzle
Missing or damaged gas diffuser	Replace the gas diffuser
Mig torch euro connect o-ring missing or damaged	check and replace the o-ring
<b>4: Wire stubbing during welding</b>	
<b>Possible Reason</b>	<b>Suggested Remedy</b>
Holding the torch too far away	Bring the torch closer to the work and maintain stick out of 5-10mm
Welding voltage set too low	Increase the voltage
Wire Speed set too high	Decrease the wire feed speed
<b>5: Lack of Fusion – failure of weld metal to fuse completely with base metal or a preceding weld bead.</b>	
<b>Possible Reason</b>	<b>Suggested Remedy</b>
Contaminated base metal	Remove materials like paint, grease, oil, and dirt, including mill scale from base metal
Not enough heat input	Select a higher voltage range and /or adjust the wire speed to suit
Improper welding technique	Keep the arc at the leading edge of the weld pool. Gun angle to work should be between 5 & 15° Direct the arc at the weld joint Adjust work angle or widen groove to access bottom during welding Momentarily hold arc on side walls if using weaving technique
<b>5: Excessive Penetration – weld metal melting through base metal</b>	
<b>Possible Reason</b>	<b>Suggested Remedy</b>
Too much heat	Select a lower voltage range and /or adjust the wire speed to suit Increase travel speed
<b>6: Lack of Penetration – shallow fusion between weld metal and base metal</b>	
Poor in incorrect joint preparation	Material too thick. Joint preparation and design needs to allow access to bottom of groove while maintaining proper welding wire extension and arc characteristics Keep the arc at the leading edge of the weld pool and maintain the gun angle at 5 & 15° keeping the stick out between 5-10mm
Not enough heat input	Select a higher voltage range and /or adjust the wire speed to suit Reduce travel speed
Contaminated base metal	Remove materials like paint, grease, oil, and dirt, including mill scale from base metal.



## MIG WIRE FEED TROUBLE SHOOTING

The following chart addresses some of the common WIRE FEED problems during MIG welding. In all cases of equipment malfunction, the manufacturer's recommendations should be strictly adhered to and followed.

<b>1: No wire feed</b>	
<b>Possible Reason</b>	<b>Suggested Remedy</b>
Wrong mode selected	Check that the TIG/MMA/MIG selector switch set to MIG position
Wrong torch selector switch	Check that the STANDARD/SPOOLGUN selector switch is set to STANDARD position for MIG welding and SPOOLGUN when using the Spoolgun
<b>2: Inconsistent / interrupted wire feed</b>	
<b>Possible Reason</b>	<b>Suggested Remedy</b>
Adjusting wrong dial	Be sure to adjust the WIRE FEED and VOLTAGE dials for MIG welding. The AMPERAGE dial is for STICK and TIG welding mode
Wrong polarity selected	Select the correct polarity for the wire being used - see machine setup guide
Incorrect wire speed setting	Adjust the wire feed speed
Voltage setting incorrect	Adjust the voltage setting
Mig torch lead too long	Small diameter wires and soft wires like aluminium don't feed well through long torch leads - replace the torch with a lesser length torch
Mig torch lead kinked or too sharp angle being held	Remove the kink, reduce the angle or bend
Contact tip worn, wrong size, wrong type	Replace the tip with correct size and type
Liner worn or clogged (the most common causes of bad feeding)	Try to clear the liner by blowing out with compressed air as a temporary cure, it is recommended to replace the liner
Wrong size liner	Install the correct size liner
Blocked or worn inlet guide tube	Clear or replace the inlet guide tube
Wire misaligned in drive roller groove	Locate the wire into the groove of the drive roller
Incorrect drive roller size	Fit the correct size drive roller eg; 0.8mm wire requires 0.8mm drive roller
Wrong type of drive roller selected	Fit the correct type roller (e.g. knurled rollers needed for flux cored wires)
Worn drive rollers	Replace the drive rollers
Drive roller pressure too high	Can flatten the wire electrode causing it to lodge in the contact tip - reduce the drive roller pressure
Too much tension on wire spool hub	Reduce the spool hub brake tension
Wire crossed over on the spool or tangled	Remove the spool untangle the wire or replace the wire
Contaminated mig wire	Use clean dry rust free wire. Do not lubricate the wire with oil, grease etc

## **ATTENTION! - CHECK FOR GAS LEAKS**

At initial set up and at regular intervals we recommend to check for gas leakage.

Recommended procedure is as follows:

1. Connect the regulator and gas hose assembly and tighten all connectors and clamps.
2. Slowly open the cylinder valve.
3. Set the flow rate on the regulator to approximately 8-12 l/min.
4. Close the cylinder valve and pay attention to the needle indicator of the contents pressure gauge on the regulator, if the needle drops away towards zero there is a gas leak. Sometimes a gas leak can be slow and to identify it will require leaving the gas pressure in the regulator and line for an extended time period. In this situation it is recommended to open the cylinder valve, set the flow rate to 8-12 l/min, close the cylinder valve and check after a minimum of 15 minutes.
5. If there is a gas loss then check all connectors and clamps for leakage by brushing or spraying with soapy water, bubbles will appear at the leakage point.
6. Tighten clamps or fittings to eliminate gas leakage.

**Important:** We strongly recommend that you check for gas leakage prior to operation of your machine. We recommend that you close the cylinder valve when the machine is not in use. Welding Guns Of Australia PTY LTD, authorised representatives or agents of Welding Guns Of Australia will not be liable or responsible for the loss of any gas.

# Spare Parts Identification - MIG180

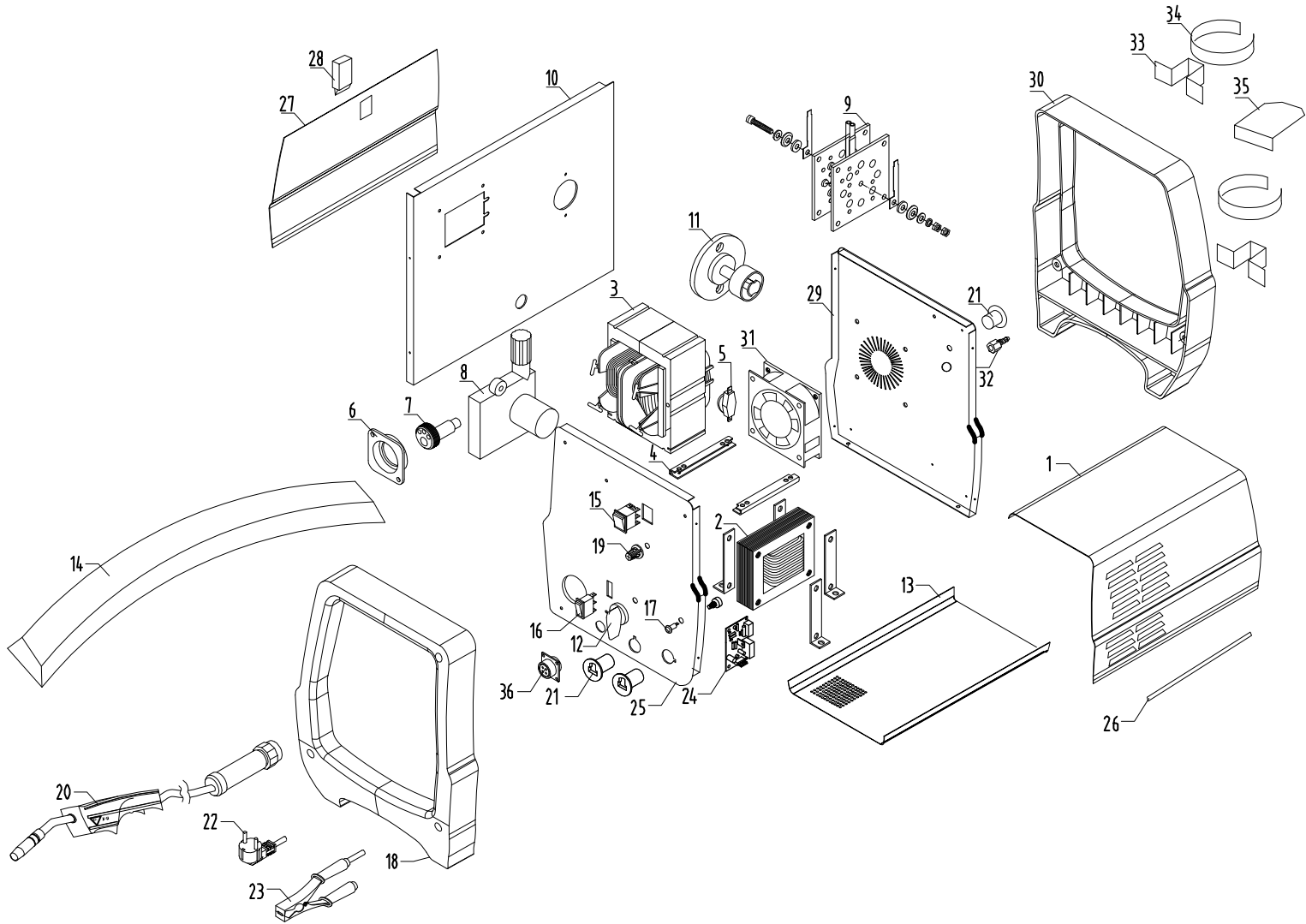

#	Part Number	Description	#	Part Number	Description
1	00.1330	Left Cover	21	00.1310	Dinse Connector
2	00.1329	Inductor	22	00.1309	Input Cable & Plug
3	00.1328	Transformer	23	00.1308	Earth Clamp
4	00.1327	Bottom Support	24	00.1306	Control Board
5	00.1326	Thermal Switch	25	00.1305	Front Panel
6	00.1325	Euro Flange	26	00.1304	Steel Liner
7	00.1324	Control Adaptor	27	00.1303	Right Cover
8	00.1323	Wire-Feeding Motor + Bracket	28	00.1302	Door Latch
9	00.1322	Rectifier	29	00.1301	Back Panel
10	00.1321	Vertical Panel	30	00.1300	Back Plastic Panel
11	00.1320	Spool Holder	31	00.1399	Fan
12	00.1319	Voltage Regulation Switch	32	00.1298	Air Connection
13	00.1318	Bottom Panel	33	00.1297	Gas Bottle Brakcet
14	00.1317	Handle	34	00.1296	Gas Bottle Clips
15	00.1316	Main Power Switch	35	00.1295	Gas Bottle Support
16	00.1315	Spool Gun Selector Switch	36	00.1294	4 Pin Socket
17	00.1314	Pilot Lamp			
18	00.1313	Front Plastic Panel			
19	00.1312	Wire Speed Potentiometer			
20	00.1311	Mig Torch			

Welding Guns Of Australia Pty Ltd ('Us', 'We') warrants that the following products under UNI-MIG, UNI-TIG, UNI-PLAS, UNI-FLAME, TECNA, T&R, HIT-8SS & ROTA, supplied by Us and purchased by you from an Authorised UNI-MIG, UNI-TIG, UNI-PLAS, UNI-FLAME, TECNA, T&R, HIT-8SS & ROTA Dealer throughout Australia are free of Material and Faulty Workmanship defects except for those products listed under 'Warranty Exclusions'.

These terms and conditions supersede and exclude all former and other representations and arrangements relating to any warranties on these products.

## WARRANTY PERIOD

We offer the following 'Warranty Periods' from 'date of purchase':

An Extended Warranty Period of 6 months total shall apply only to Machinery where offered and warranty is registered online.

### UNI-MIG WELDING MACHINES

UNI-MIG DIY Series (Power Source Only)	2 Years	(Clause 3)
UNI-MIG Procraft Series (Power Source Only)	3 Years	(Clause 1&3)
UNI-MIG Trade Series (Power Source Only)	3 Years	(Clause 1&3)
UNI-MIG Trade Series SWF (Power Source / Seperate Wire Feeder Only)	3 Years	(Clause 1&3))
UNI-MIG Workshop Series (Power Source Only)	3 Years	(Clause 1&3)
UNI-MIG Workshop Series SWF (Power Source / Separate Wire Feeder Only)	3 Years	(Clause 1&3)
UNI-MIG Jasic Inverter MIG (Power Source Only)	3 Years	(Clause 3)
UNI-MIG Jasic Inverter MIG SWF (Power Source / Separate Wire Feeder Only)	3 Years	(Clause 3)
UNI-TIG Jasic Inverter TIG (Power Source Only)	3 Years	(Clause 3)
UNI-MIG Water Cooler	1 Year	(Clause 3)
T&R Pulse MIG (Power Source Only)	2 Year	(Clause 3)
T&R Pulse MIG SWF (Power Source / Separate Wire Feeder Only)	2 Year	(Clause 3)
UNI-PLAS (Power Source Only)	3 Years	(Clause 3)
UNI-PLAS Jasic Series (Power Source Only)	2 Years	(Clause 3)
UNI-PLAS Site Cut Series (Power Source Only)	1 Year	(Clause 3)
UNI-FLAME Gas Cutting and Welding Kits	3 Months	(Clause 2&3)
UNI-FLAME Straight Line & Gas Cutting Machines (Power Source Only)	1 Year	(Clause 3)
UNI-FLAME Regulators Argon/ Acetylene / Oxygen / LPG / Bobbin Flowmeter	1 Year	
UNI-FLAME Automatic Welding Helmet	2 Years	
UNI-MIG Automatic Welding Helmets	2 Years	
TECNA (Power Source Only)	1 Year	(Clause 3)
HIT-8SS Automatic Carriage (Power Source Only)	1 Year	(Clause 3)
ROTA 102 Rotating table	1 Year	
HOTBOX ElectrodeOven	1 Year	
SPOTCAR 3500	1 Year	(Clause 3)
TORCHES -GMAW, GTAW, MMAW, PLASMA, EARTH LEADS, INTERCONNECTING CABLES, GAS HOSE	3 Months	(Clause 3)

**(Clause 1)** 3 year warranty on transformers, inductor and rectifier. 1 year warranty on PCB, and all other components, .

**(Clause 2)** Gas Hose, Flashbacks are subject to and covered by the Manufacture's Individual Warranty, Contact the manufacturer for details

**(Clause 3)** This only Covers Manufactures defaults on all accesories for the first three months after date of purchase.

## WARRANTY / RETURNS / EXCHANGES

We understand that sometimes you may need to return a product you have purchased from Welding Guns Of Australia PTY LTD Authorised Dealer Network, to assist you, we have set out below the Welding Guns Of Australia PTY LTD Returns Policy that you should know.

Our Returns Policy includes the rights you have under the Australian Consumer Law and other relevant laws. Your Rights under the Australian Consumer Law - Our goods come with guarantees that cannot be excluded under the Australian Consumer Law. You are entitled to a replacement or refund for a major failure and for compensation for any other reasonably foreseeable loss or damage. You are also entitled to have the goods repaired or replaced if the goods fail to be of acceptable quality and the failure does not amount to a major failure.

- You shall inspect the Goods on delivery and shall within seven (7) days of delivery (time being of the essence) notify Welding Guns Of Australia PTY LTD of any alleged defect, shortage in quantity, damage or failure to comply with the description or quote.
- You shall also afford Welding Guns Of Australia PTY LTD the opportunity to inspect the Goods within a reasonable time following delivery if you believe the Goods are defective in any way.
- If you shall fail to comply with these provisions the Goods shall be presumed to be free from any defect or damage. For defective Goods, which Welding Guns Of Australia PTY LTD has agreed in writing that you are entitled to reject, Welding Guns Of Australia PTY LTD liability is limited to either (at the Welding Guns Of Australia PTY LTD discretion) replacing the Goods or repairing the Goods except where you have acquired Goods as a consumer within the meaning of the Trade Practices Act 1974 or the Fair Trading Acts of the relevant state or territories of Australia, and is therefore also entitled to, at the consumer's discretion either a refund of the purchase price of the Goods, or repair of the Goods, or replacement of the Goods.

Returns will only be accepted provided that:

- (a) You have complied with the provisions outlined above, and
- (b) where the Goods are unable to be repaired, the Goods are returned at your cost within thirty (30) days of the delivery date, and
- (c) Welding Guns Of Australia PTY LTD will not be liable for Goods which have not been stored or used in a proper manner, and
- (d) the Goods are returned in the condition in which they were delivered and with all packaging material, brochures and instruction material in as new condition as is reasonably possible in the circumstances.

- Welding Guns Of Australia PTY LTD Accepts no responsibility for products lost, damaged or mislaid whilst in transit
- Welding Guns Of Australia PTY LTD may (at their sole discretion) accept the return of Goods for credit but this may incur a handling fee of up to fifteen percent (15%) of the value of the returned Goods plus any freight costs.
- Where a failure does not amount to a major failure, Welding Guns Of Australia PTY LTD is entitled to choose between providing you with a repair, replacement or other suitable remedy.
- Your rights under the Australian Consumer Law are not limited by a defined time. However, the Australian Consumer Law does recognise that the relevant time period can vary from product to product, depending on factors such as the nature of the product and the price. Welding Guns Of Australia PTY LTD adopts the same approach. As you can appreciate, the type of remedy we can offer you may also vary depending on how long it takes you to return the product to us.

## MAKING A CLAIM

If you wish to make a claim under this Warranty, you should:

- Return the product to the point of purchase either in person or on a prepaid courier; or
- Contact Us by Telephone on 02 9870 4200 or Mail PO Box 3033 Lansvale NSW 2166.

When returned, the product must be accompanied with the original invoice including the purchase price and disclosing the purchase date

All costs of installation, cartage, freight, travelling expenses, hiring tools and insurance are paid by the Customer.

To the extent permitted by law, our total liability for loss or damage of every kind related to the product in any way whatsoever is limited to the amount paid to the retailer by you for the product or the value of the product.

No responsibility will be taken for products lost, damaged or mislaid whilst in transit.

# WARRANTY EXCLUSIONS

This Warranty covers Material and Faulty Workmanship defects only.  
This Warranty does not cover damage caused by:

- Normal wear and tear due to usage
- Misuse or abusive use of the UNI-MIG, UNI-TIG, UNI-PLAS, UNI-FLAME, TECNA, T&R, HIT-8SS & ROTA, instructions supplied with the product.
- Failure to clean or improper cleaning of the product
- Failure to maintain the equipment such as regular services etc
- Incorrect voltage or non-authorized electrical connections
- Improper installation
- Use of non-authorized/non-standard parts
- Abnormal product performance caused by any ancillary equipment interference or other external factors
- Failure or any breakage caused by overload, dropping or abusive treatment or use by the customer
- Repair, modifications or other work carried out on the product other than by an Authorized UNI-MIG, UNI-TIG, UNI-PLAS, UNI-FLAME, TECNA, T&R, HIT-8SS & ROTA Service Dealer

Unless it is a manufacturing fault, this Warranty does not cover the following parts:

## **MIG Welding Torches and Consumables to suit, such as:**

Gas Nozzels, Gas Diffusers, Contact Tip holder, Contact tip, Swan Necks, Trigger, Handle, Liners, Wire Guide, Drive Roller, Gas Nozzle Spring, Neck Spring, Connector Block, Insulator, Gas Nipple, Cap, Euro Block, Head Assembly, Gas Block, Trigger Spring, Spring Cable Support, Neck Insulator, Shroud Spring, Gun Plug Cover, Lock Nut, Snap On Head, Spring Cap, Ball, Motor 42 Volt, Pot 10K standard, Knob, Drive Roll Seat, Washer, Bow, Ball Bearing, Wire Condue Nipple, Central Plug, Printed Circuit Board, Gun Plug House, Cable Support, Gas Connector, Handle To Suit PP36 with Knobs, All Xcel-Arc/ Magmaweld Mig Welding Wires & Electrodes, Arc Leads, Welding Cable, Electrode Holder, Eatch Clamps

## **TIG Welding Torches and Consumables to suit, such as:**

Tungsten Electrodes, Collet, Collet Body, Alumina Nozzle, Torch Head, Torch Head water Cooled, Torch Head Flexible, Back Caps, Gas Lens, Torch Handle, Cup Gasket, Torch Body Gas Valve, O-ring, All UNI-MIG TIG Welding Rods, All Xcel-Arc/ Magmaweld Electrodes, Arc Leads, Welding Cable, Electrode Holder, Eatch Clamps.

## **PLASMA Cutting Torches and Consumables to suit, such as:**

All Cutting Tips, All Diffuser/Swirl Ring, All Electrode, Retaining Caps, Nozzle Springs, All Spacers, All Shield Caps, All Air and Power Cables, All Switches, All O-rings, All Springs, All Circle Guides and Cutting Kits, Torch Bodies, Air Filter Regulator, Arc Leads, Welding Cable, Electrode Holder, Eatch Clamps

## **STRAIGHT LINE CUTTING MACHINES and Consumables to suit, such as:**

Hoses, Fittings, Track, Cutting Nozzles.

## **HIT-8SS Welding Carriage Consumables to suit, such as:**

Input Cord, Inter-connecting Cord, Triggering Cable.

This Warranty does not cover products purchased:

- From a non-authorized UNI-MIG, UNI-TIG, UNI-PLAS, UNI-FLAME, TECNA, T&R, HIT-8SS & ROTA Dealer (such as purchases from unauthorised retailers and purchases over the Internet from unauthorised local/international sellers or sites such as EBay)
- At an auction;
- From a private seller

Unless it is a manufacturing fault, this Warranty does not apply to any products sold to Hire Companies.

These conditions may only be varied with the written approval of the Directors of Welding Guns Of Australia PTY LTD

**REMEMBER TO RETAIN YOUR ORIGINAL INVOICE FOR PROOF OF PURCHASE.**





*Welding Guns Of Australia PTY LTD Pty Ltd*  
ABN: 14 001 804 422

PO Box 3033, Lansvale NSW 2166, AUSTRALIA

112 Christina Rd, Villawood, NSW 2163

Phone: (02) 9780 4200

Fax: (02) 9780 4244

Email: [sales@unimig.com.au](mailto:sales@unimig.com.au) / Web: [www.unimig.com.au](http://www.unimig.com.au)